

DigiSpecTM

DS1-PL

DIGITAL VIDEO MOTION DETECTOR



Version 10

OPERATION MANUAL

January 2007

CONTENTS

Introduction	4
Features	5
5 Different Operation Modes	5
Motion Detection Parameter	5
Viewing Modes	5
Motion Detection Set Up	5
Specifications	7
Detection Parameter	7
Zone Pattern Grid	7
Alarm Outputs	7
Connecting the Video	8
Type of Cameras	8
Cable	8
Lighting & Environment	8
Day / Night	8
Florescent Lighting	9
Video Input / Output	9
Connecting the Alarms	9
Alarm Output	9
Alarm Connector DB-15	10
Day / Night Inputs	10
RS-232	10
Connecting the Power	10
Operation	11
Button Operation	12
Normal Running Mode Button Functions	12
Programming Mode Button Functions	13
Day / Night Mode	13
Log Mode	13
On-Screen Display during Running Operation	14
Video Loss	15
Programming the DS1-PL	15
1. Motion Detection Menu	15
The Mode Setting	16
The Three Motion Detection Criteria	16
The Trigger Level	18
The Sensitivity Setting	19
The Tracking Time Setting	19
2. Zone Pattern Mask Menu	19
The Cursor	20
Button Function	20
3. Alarms, Relays, Menu	21
Buzzer Setting	22
Relay Output Setting	22
External Input Setting	23
Watchdog Timer	24
Entrance Delay Setting	24
Exit Delay Setting	24
Alarm Process	24
Alarm Output Time Setting	24
Alarm Reset Time Setting	25

CONTENTS

4. Timers Menu	25
The 3 On-Off Timer Settings	25
Start and Stop Times	26
Timer Examples	26
The Day/Night Timer Setting	28
5. On-Screen Data Menu	29
The Layout Setting	29
The Position Settings	29
The Status Settings	30
The Calendar Display Setting	30
The Time Display Setting	31
The Trace Effect Setting	31
The Video Blackout Setting	33
The Titler Display Setting	33
6. Camera Titler Menu	33
The Titler Settings	34
7. Date-Time Menu	34
The Date Time Settings	34
Clearing The Alarm Counter	34
8. Serial Port Menu	35
The Mode Setting	35
The Address Setting	35
The Output Rate Setting	36
The Output Data Setting	36
TCP/IP	36
9. Video Loss	37
Video Loss Alarm	37
Video Loss Buzzer	37
Video Loss Alarm Output	37
10. Master Reset	38
APPENDIX A	38
DS1-PL Feature / Alarm Connector	38
DS1-SPL Feature / Alarm Connector	38
APPENDIX B	39
Ethernet LAN Adpater	39
LAN and DS1-PL Connection	39
APPENDIX C - Cable Pinouts	39
APPENDIX D - DSVMD Software	40
Installation	40
Opening Window	40
Serial Connection	40
Ethernet Connection	41
Setup IP Address	41
Communications Complete	42
Main Menu	42
APPENDIX E - Serial Protocol Rev 10	43
APPENDIX F - PC to DS1-PL Connection Pin Out	49
Limited Warranty	50
NOTES	51

LIST OF TABLE

Table 1 : DB-15 Pin-Out	10
Table 2 : DB-15 Female Connector	38
Table 3 : LAN Adapter or PC to DS1-PL PinOut	39
Table 4 : LAN Adpater to PC PinOut	39
Table 5 : LAN Adapter or PC to DS-16	39

LIST OF FIGURES

Figure 1 : Video Input / Output	8
Figure 2 : DS1-PL BASIC CONFIGURATION	11
Figure 3 : Button Operation	11
Figure 4 : Trace "Memory"	32
Figure 5 : Trace "Memory Strobe"	32
Figure 6 : Blackout "On" & Trace "On"	32
Figure 7 : Blackout "Auto"	32
Figure 8 : LAN and DS1-PL Connection	39
Figure 9 : Software Select Window	40
Figure 10 : Setting Window	40
Figure 11 : DS1-PL to Laptop Serial Connection	40
Figure 12 : Setting IP & Baud Rate Window	41
Figure 13 : LAN Adpater to Laptop Connection	41
Figure 14 : IP Address Setting Comport	41
Figure 15 : IP Address Setting	41
Figure 16 : Main Menu DSVMD	42
Figure 17 : PC to DS1-PL Connection Pin-Out	49

INTRODUCTION

Congratulations on your purchase of the DigiSpec DS1-PL Digital Video Motion Detector. You are now the owner of one of the most innovative, precise and reliable motion detectors available today. DigiSpec would like to personally thank you for your purchase and would like to provide you with additional information on this remarkable product. The DS1-PL utilizes a new technology developed by DigiSpec called Quantivision. This development divides the video image into over 262,144 pixels and analyses it 30 times per second for NTSC and 25 times per second for PAL. This insures instantaneous motion detection on a real time basis. By utilizing pipeline processing, DS1-PL handles millions of calculations per second, which greatly decreases the decision time and increases reliability.

Traditionally, motion detection has been used for surveillance and security applications. Special features such as the Black-Out, Trace, and Museum Modes as well as the Delta Effect allow security personnel to quickly ascertain and respond to suspect motion. These features and many more are just small examples of the innovation built into this product. This unit is perfect for indoor or outdoor, low light and difficult applications. Regardless of the job, the DS1-PL can handle it.

The flexibility of this unit has been proven in a variety of environments. Machine vision systems have been developed within the industrial marketplace. The DS1-PL has also been utilized to assist in ground breaking research in the Medical arena. The extreme sensitivity of this product allows very precise analysis of any video image in airport ques and immigration. By utilizing the unit's RS-232 port and/or LAN adpaters and a personal computer, motion can be studied and plotted over time or output to a paper chart recorder to facilitate motion signature analysis. The limit of the DS1-PL is limited only to the creativity of the user.

Regardless of your application the DS1-PL will open up numerous possibilities for you. This ground breaking technology is representative of our commitment to Quality, Value and Innovation in every product we manufacture. We are and will continue to be The Leader in Digital Video Motion Detection Technology.

Thank You

DigiSpec Inc.

1906 Treble Dr. Houston, Texas 77338
Telephone 702-341-0333 Fax 702-341-0334
Email: john@digispecvideomotion.com
Web Site: www.digispecvideomotion.com

WARNING !

TO PREVENT FIRE OR ELECTRIC SHOCK, DO NOT EXPOSE THIS APPLIANCE TO RAIN OR MOISTURE !

WARNING!

THIS EQUIPMENT GENERATES , USES AND CAN RADIARE RADIO FREQUENCY ANDIF NOT INSTALLED AND USED IN ACCORDANCE WITH THE INSTRUCTIONS MANUAL , MAY CAUSE INTERFERERCE TO RADIO COMMUNICATIONS IT HAS BEEN TESTED FOUND TOCOMPLY WITH THE LIMITED FOR A CLASS A COMPUTING DEVICE PURSUANT TO SUBPART JOF PART 15 FCC RULES, WHICH ARE DESIGNED TO PROVID REASONABLE PROTECTION AGAINT SUCH INTER-FERENCE WHEN OPERATED IN A COMMERCIAL ENVIROMENT. OPERATION OF THIS EQUIP-MENT IN A RESIDENT AREA IS LIKELY TO CAUSE INTERFERENCE IN WHICH CASE THE USER AT HIS OWN EXOENSE WILL BE REQUIRED TO TAKE WHATEVER MEASURES MAY BE REQUIRED TO CORRECT THE INTERFERENCE



DS1-PL Features

PTZ Mode

This mode allows the use of Pan/Tilt/Zoom cameras while operating in the VMD mode. The unit electronically monitors the entire video image and if the entire screen is moving simultaneously then this is determined to be a PTZ moving. The VMD is disabled until the PTZ comes to rest and then enables the VMD function after a programmable period of time.

Tracking Modes

The popular "Trace" modes of the DS1-PL have been enhance to allow motion tracking to be displayed and saved on the screen. Unlike other units that have arrows or boxes we actually display the form outline of the motion tracking target, so the user can easily identify friend or foe and travel direction.

TCP/IP LAN Compatibility

The DS1-PL and DS-16 Rack now can be easily added to networked systems via the new LAN adapter using UDP protocol of standard ethernet LAN systems. This adds convenience and flexibility in large enterprise or proprietary systems.

DSVMD Windows Software

New and improved features of the powerful Windows based programming and control software. Fully compatible with our TCP/IP LAN and interface and included with at no additional charge.

Watchdog Timer Output

The DS1-PI can be programmed to give a periodic signal output to inform other equipment the VMD is continuously online via this hardware signal. The DS1-PL always had a Watchdog timer input to monitor other equipment when they are operational via our Alarm input function.

Video Loss Mode

This mode has added some programming features to make the video loss mode more flexible when interfacing with other equipment down the line.

Alarm Process

The alarm modes have also been enhanced to allow for dwell or timed modes for ease in interfacing to other alarming devices.

Features

5 Different Operating Modes

- Motion Detection - 1 to 8 Zones for Perspective Detection
- Motionless Detection - 1 to 8 Zones
- Direction Detection - Up to 4 Directions
- Museum Mode
- PTZ-Compatible Mode

Motion Detection Parameters

- Tracking Time - Velocity of Movement
- Size - Number of Pixels that Change
- Sensitivity - Amount of Contrast Changes
- 288 Programmable Areas Maximum per Zone
- 8 Independently Programmable Zones

Viewing Modes

- Trace Mode - Outlines Moving Targets in memory or strobe mode
- Blackout Mode
- Blackout and Trace Modes Combined

Motion Detection Set-Up

- Total Pixel Count
- Peak Pixel Count
- Alarm Count by Zone

- Analyzes video at the pixel level with 262,144 detection points
- On-Screen Menus
- 160-Entry Event Log
- Video Loss with Programmable audible, red screen or alarm output
- 3 Daily Timers for On/Off and Weekend/Holiday Settings
- NTSC/RS-170A, PAL/CCIR, and SECAM Compatible
- Asynchronous; requires no external camera synchronization
- Buzzer Settings for Alarm and Proximity Detection
- Date/Time generator with all International Standards and Daylight Savings
- NiMH Battery Backup for Date/Time when power is lost
- Internal Day / Night Timer
- Day / Night modes can be switched by external devices
- 8 Individual Zone Alarm Outputs
- 1 Global Form C alarm output - NC and NO with common
- 1 Alarm Input ("AND/OR/Enable/Disable" Selectable)
- Non-Volatile EEPROM Backup Memory
- 16-Character Camera Titling
- RS-232 Programming via PC for all Functions and Setups
- Ethernet LAN Programming with optional adapter
- Serial Printer Port for printing Event Log
- Watchdog Timer Internal and Output
- Programmable Alarm Process either Time or Retrigger
- Powerful Windows-based Software for set-up and control

Specifications

Specifications

Motion / Direction / Motionless / Museum / PTZ Modes Detection Parameters

Size Settings; 0 - 65,535 pixels
 Sensitivity Settings; 0 – 100
 Tracking Settings; 0 – 8 seconds, in 0.1 second increments

Zone Pattern Grid: 288 Zones (NTSC or PAL)

Video Input: 1 V P-P, 75 ohm terminated, NTSC, PAL, SECAM +/- 20%
 Video Output: 1V P-P 75 ohm terminated or unterminated
 Video Input / Output: BNC individual video loop-through outputs per channel

Alarm Outputs

Time: 0-99 seconds
 8 Individual Zone Outputs, open collector transistor via DB-15 (20ma Max. at 12VDC)
 Watchdog Timer Output uses Alarm Output H when selected
 Global Form C output, either N/O or N/C with common (1A Max at 12-24 VAC / VDC)

Alarm Input	HiZ 100K ohm 12VDC Max
Programming	On-Screen with Momentary Pushbuttons for selection or RS-232 / LAN
Serial Communication	RS-232C with open API command set
Status Indicators	Power : Green LED (Solid On when power applied) Alarm Mode : Red LED (Solid On when enabled, OFF when disabled, and Flashing when alarm active) Setup : Yellow LED Day / Night : Green LED (On when day mode, OFF when night mode) LOG : Yellow LED (On when LOG is being displayed on-screen)
Trace Gray Scale	<i>White to Gray Adjustable internal control</i>
Backup Program Memory	Non-Volatile EEPROM memory
T/D Backup	4 days via Super Capacitor (without power connected)
Power	7-15VDC 3.3W Max via 2.1mmx5.5mm DC Power Jack 12VDC @ 160mA Nominal 12VDC @ 220mA when Alarming and Buzzer sounding
Size	230mm(D)x130mm(W)x38mm(H) / 9"(D)x51/8"(W)x1.5"(H)
Weight	1 lb / .46 Kg
Construction	Computer Beige Metal Enclosure
Warranty	2 years, parts and labor

Connecting the Video

Type of Cameras

Precautions

The DS1-PL functions best with high quality video cameras. Cameras must be securely locked down so the picture is stable and jitter free. If the picture jitters or the DS1-PL character display jitters, the DS1-PL may false trigger. If the camera has any sync or phase adjustments, try adjusting these first.

To select the right camera for your application (i.e. indoor, outdoor, low light, no light), you should consider the advantages and disadvantages of each type.

CCD

High quality CCD cameras will work well with the DS1-PL. The higher the resolution, the more precise the motion detection. CCD cameras work equally well in both indoor and outdoor environments. It is recommended that B&W CCD cameras be using in outdoor applications due to their increased resolution. B&W low light level CCD cameras should be used in low light conditions. CCD cameras are sensitive to Infrared (IR) light and can be used for night vision with the aid of an Infrared Illuminator.

IR

Infrared cameras should be used for no light applications or very sensitive night vision applications. IR cameras are better equipped for night vision than CCD cameras.

Cable

It is important that you use the proper cable type and installation procedures when installing the cameras and your DS1-PL. Make sure you use standard RG-59U coaxial cable with at least 95% braided shield for video transmission.

When installing, make sure that you do not run the cable near any power lines for they may cause interference in the video transmission. If you are cabling between floors or long distances, use conduit to protect the cable from interference. Proper protection of the video cable from external power interference, weather, and water is important to ensure a clear transmission of video signal and reliable motion detection.

Grounding problems between the various components of a video system may cause noise or hum bars to appear in the video image. This must be eliminated by properly grounding all equipment to an earth ground and making sure all shields are intact in all video coaxial cables. Grounding problems will effect the reliability of motion detection.

Lighting & Enviromental Conditions

Unless a camera is in a controlled environment, fluctuations in conditions will occur. The DS1-PL provides the flexibility to configure the Video Motion Detector for two separate sets of conditions.

Day/Night

The DS1-PL works in both the day and night environments. But, each may require different configurations. The DS1-PL provides two sets of settings that can be programmed by the user. One group of settings can be used for day settings and the other for night settings or for whatever other conditions the user wishes to set them for. Night settings require higher sensitivity, lower trigger levels, and shorter tracking times, making the DS1-PL more sensitive to motion. The Day/Night mode may be toggled from day to night by giving a relay closure to ground on the Day/Night input – Pin 8 or using the Day/Night timer to switch modes at a predetermined time.

Refer to Table 1 for more information.

Connecting

Florescent Lighting

Gradual or sudden lighting changes, video noise, intermittence or glitches in video lines, or power surges can be ignored by the DS1-PL. To compensate for such occurrences a balance must be reached in the configuration of the motion criteria (see Motion Criteria). Fluorescent light may result in high speed flickering when a CCD camera is used. Various cameras have shutter selections for flickerless option or you may have to disable the Auto White balance feature on DC versions. Another solution is to change the lighting ballast to an electronic one that operates at a higher frequency than the video sync signal.

Video Input / Output

The video input and output are located on the rear of the unit. (see Figure 1). The video input connects to the video source via the left BNC connector. The video output connects to a display, recording device, switcher, or other equipment via the right BNC connector. Both the input and output are 1 V P-P into 75 ohms unbalanced EIA standard RS-170A / NTSC or CCIR / PAL video format. Improper input termination or looping will cause the video level to be too low and effect the motion detection. Improper output termination will make the image or the video recording poor.



Figure 1 : Video Input / Output

Connecting the Alarms

Alarm Output

The unit has one Form-C alarm output with normally open (N/O) and normally closed N/C configurations. It will produce a closure and open whenever an alarm occurs. An alarm occurs when the DS1-PL detects motion or there is video loss and the alarm has been enabled by pressing the ALARM ON-OFF button (red LED on). The contacts remain closed or open for the duration programmed in the Relay Hold time. If the unit is set with a Relay Hold time of zero, no alarm will be produced. The location of the alarm output connector is seen in Figure 1 and the pin-out configuration for the DB-15 connector is seen in Table 1. An alarm connector adapter is provided with the unit. All signals of the DB-15 connector can be connected to this adapter via the screw terminals.

Some equipment may require a dry contact closure (normally open). Connect such equipment to the N/O and common leads. For a normally closed alarm, connect between the N/C and common leads. There is no polarity; so these leads may be swapped around or AC voltages used. Other equipment may require a closure to ground. In this case, a ground connection will be provided on such equipment. Connect the common lead to ground and the N/O lead to the input of the equipment. There is no voltage on the alarm connectors of the DS1-PL. No damage can be done by incorrect wiring except exceeding the current or voltage rating.

Connecting

Alarm Connector DB-15

The DS1-PL has a female DB-15 Alarm connector with the following pin out for additional functions.

Pin #	Function
1	Alarm Area A
2	Alarm Area B
3	Alarm Area C
4	Alarm Area D
5	Alarm Area E
6	Alarm Area F
7	Alarm Area G
8	Alarm Area H
9	N/C (Normally Closed) Universal Alarm
10	N/O (Normally Open) Universal Alarm
11	Com (Common) Universal Alarm
12	Ground
13	RS-232 Serial Output (TXD)
14	RS-232 Serial Input (RXD)
15	External Contact Input
Shield	Ground

Table 1 : DB-15 Pin Out

Note

Pins 9-11 are Form C relay contact
Pins 1-8 are open collector transistor outputs (normally open)
Pin 15 is HiZ 100K ohm Max 12VDC input for Alarm or Day/Night mode

Day/Night Inputs

The Day/Night input switches settings from day settings to night when the unit receives a closure to ground on the external contact input. If left open, day settings will be effective. An external timer, switch or photo cell can be used to switch from day to night.

RS-232

The DS1-PL has an RS-232 interface for motion analysis and system configuration and operation that can be used in conjunction with a PC or any RS-232C transmitting device. The DSVMD Windows based software gives complete programming and operational command to the DS1-PL. The standard command set can be used to integrate control functions within the users proprietary system for total system solution. See the Serial Protocol section on page 44 for the complete command set.

Connecting the Power

The DS1-PL operates from a DC supply range from 7V to 15V DC. The power input connector, a standard 2.1mm x 5.5mm power jack, must have positive (+) on the center and negative (- or ground) on the outer shell. The unit is reverse protected and correct polarity is indicated by the green Power LED being lit on the front panel.

For mobile operation a negative ground system is required. The unit may be operated from regular household power with the appropriate adapter.

Operation

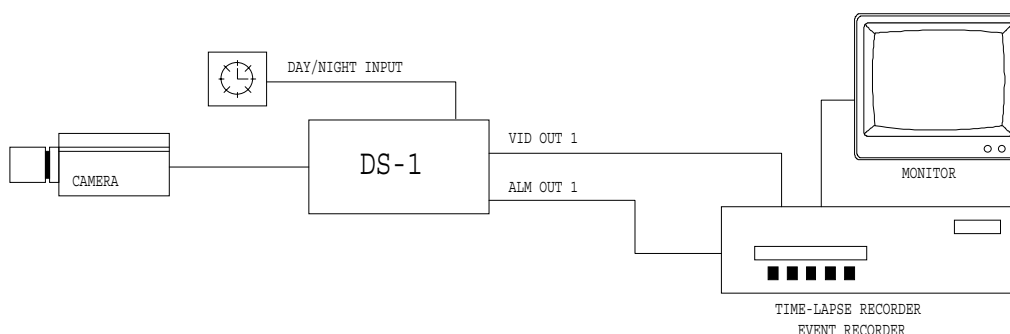

Figure 2 : DS1-PL BASIC CONFIGURATION

DESCRIPTION

The DS1-PL is most commonly used for single channel systems requiring precision video motion detection. An alarm output can be used to trip an event or time lapse recorder into real-time recording. An external timer can be used to toggle the DS1-PL between Day and Night modes. Since the unit is 12V DC, it is perfect for covert surveillance applications. An optional RS-232 remote communicating device can be used for programming and operation remotely.

Operation

Four buttons on the front panel give full control of the unit. All settings are guided by on-screen prompts. Simply press the MENU button and follow the on-screen instructions.

The five LED's indicate the state of the unit. The green Power LED indicates the unit is connected to the appropriate power source. The red ALARM LED indicates the unit is armed when solid and alarmed when flashing. The yellow LED above the MENU button indicates the unit is in the set-up mode. The green LED above the D/N button is lit when the unit is in the day mode and off when in the night mode. The yellow LED above the LOG button is lit when the unit is displaying the Log Page on-screen.



Figure 3 : Button Operation

Operation

Button Operation

The DS1-PL has 4 buttons, with associated LED's, to provide all necessary functions. There are four modes of operation of the DS1-PL

- 1) Normal Running Mode
- 2) Programming Mode
- 3) Day/Night Mode
- 4) Log Mode

1) Normal Running Mode Button Functions

In this mode, the DS1-PL is processing alarms (if enabled) and displaying the date-time (if enabled). The button functions which are written *below* each button, and are as follows

Alarm Button The Alarm button toggles between alarm enabled or disabled. When the alarm is enabled, the DS1-PL will generate alarms whenever the motion detector qualifies valid motion. When the alarm is disabled, all motion will be ignored. There are 2 indicators which display the alarm enable/disable status. The red LED on the Alarm button will be lit during alarm enabled and will be off during alarm disable. On-screen, the Alarm enabled status will display "A" if alarms are enabled, and "a" if alarms are disabled.

If an alarm is active (i.e. the DS1-PL is generating an alarm) the red LED will be flashing. Pressing the Alarm button will clear the alarm. Every time the Alarm button is pressed thereafter, alarms will toggle between enabled/ disabled again.

Note

The 3 On-Off timers will override the front panel alarm enable/disable toggle when their start or stop times are reached. If you want to manually control the enabling from the front panel, you should disable all 3 On-Off timers, in the Timers Menu.

Program Button The Program button starts the programming mode, which brings up the Main Menu on screen with a blue back ground. The yellow LED will be lit while in this mode.

Day/Night Button The Day/Night button toggles between day and night settings. The DS1-PL can be programmed for two independent settings, called Day and Night, but these do not necessarily mean programming is required for Day and Night. It could be any time of the day or if there is any need to switch between two programmed settings. There are 2 indicators which display the Day/Night status. The green LED on the Day/Night button will be lit during Day settings and will be off during night settings. On-screen, the Day/Night status will display "d" during day settings and "n" during night settings.

Note

The day/night timer will override the front panel day/night button when their start or stop times are reached. If you want to manually control the day/ night switching from the front panel, you should disable the day-night timer, in the Timers Menu.

Operation

Log Button The Log button displays the Log Page on-screen on a green background. This displays the most recent 160 alarm events, with their dates and times. Pressing the left/right buttons scrolls forwards or backwards through the log. Pressing the Menu button prints the complete log. Pressing the Clear button reverts back to normal running operation. The yellow LED will be lit above this button while in the Log Display mode.

2) Programming Mode Button Functions

In this mode the DS1-PL is being set up. The yellow LED on the Menu button will be lit, and the screen will have a blue background (except for zone pattern settings). The button functions are as follows:

Clear Button The Clear button is used to leave menu one level up or revert back to normal running operation if current page is main menu page. If any changes were made, they will be saved to non-volatile memory and these changes will take immediate effect on the operation of the DS1-PL.

Menu Button The Menu button steps through the programming options which are displayed on screen with flashing prompts. Each time the menu button is pressed, the next prompt will flash indicating that you may set this prompt. At the end of each menu page, the last prompt will wrap around to the top of the page (the first prompt).

Left Button The Left button is used to set the prompt by reducing its value if it is numeric, or sequencing backwards if it is a text prompt. During zone pattern settings, the cursor will move to the left. If you hold the Left button pressed for longer than a second, many of the settings will automatically change 3 times per second, or the zone pattern cursor will move left at a rate of 5 times per second.

Right Button The Right button is used to set the prompt by increasing its value if it is numeric, or sequencing forwards if it is a text prompt. During zone pattern settings, the cursor will move to the right. If you hold the Right button pressed for longer than a second, many of the settings will automatically change 3 times per second, or the zone pattern cursor will move right at a rate of 5 times per second.

3) Day/Night Mode

The DS1-PL has two sets of programming setups, one for Day and one for Night. The Green LED above the D/N button when lit signifies the unit is in the Day mode. When the light is not lit the unit is in the Night mode. This light can be controlled by the front panel button D/N, RS-232 command, or external input when selected as Day/Night input or the internal timer.

4) Log Mode

The Log mode is constantly enabled and every event is recorded into the Log memory. When the Log memory is full to its maximum of 160 events, the oldest event is discarded and the newest event replaces it. To enter the Log Mode, press the LOG button on the front panel. The screen will have a green background and the latest logged events will be present on the screen. Repeatedly press the LOG button to scroll through all the stored logged events. Press the D/N button to scroll the opposite direction through the Log File. To exit, press the Alarm button to return to normal operation. The Log mode can be entered by remote RS-232 operation also. The Log memory can not be erased unless you do a complete system Master Reset which will set all the programmed settings to the factory defaults.

On-Screen Display during Running Operation

During normal running mode, various information is overlaid onto the video picture. This is used as status information, to be recorded to tape, or viewed by the person watching the monitor. Any or all this information may be turned on or off. Refer to the On-Screen Data programming screen. There are 2 layout formats, Stacked and Series. This is set so that image information is not obscured by this overlaid on-screen data. Stacked creates a tall and narrow display format. Series creates a short and wide display format. The position of this block of information can further be positioned anywhere on the screen by adjusting the horizontal and vertical position in the On-Screen Data programming screen.

Series



Stacked

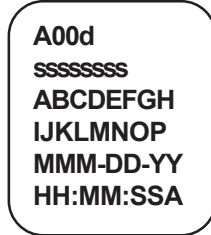

Description

ABCDEFGHIGH	16-character camera ID. Letters, numbers, and special characters
IJKLMNOP	split into 2 blocks of 8 characters each if stacked.
ssssssss	<p>Status display of up to 8 areas as defined in the zone pattern setup. Indicates areas A-H from left to right. Each of these 8 status indicators displays information pertaining the defined area, and there are 5 symbols used to indicate the status</p> <ul style="list-style-type: none"> 1) space Area is not enabled 2) . (dot) Area is enabled 3) -(dash) Area has motion 4) a - h Area has motion exceeding trigger level (a-h for respective area) Use this as an indicator to assist in adjusting trigger level. 5) A - H Area has qualified alarm (A-H for respective area) Use this as an indicator to assist in adjusting tracking time.
MMM-DD-YY	Month (in 3 character alpha format, e.g. JAN,FEB,MAR...), Date, and Year. The sequence of these can be changed at the Calendar mode prompt, in the On-Screen Data set-up menu, for USA, Canadian, European, or Japanese formats.
HH:MM:SSA	Hours, Minutes, Seconds, and AM/PM flag. The format can be changed in the Time mode prompt to display 12-hour mode (with AM/PM), or 24-hour mode (military time). Whichever mode chosen will also be used in the Timer mode menu screen.
A00d	<p>Alarm Enable Status, Alarm Counter, Day/Night Status.</p> <p>Alarm Enable status will display "A" (upper case) when alarming is enabled (the red LED will also be lit), or "a" (lower case) when alarming is disabled (the red LED will also be off). During an alarm output condition, the status will change to a "*" (asterisk) and at the end of the alarm output it will revert back to "A".</p> <p>The Alarm Counter counts up from 00 to 99 every time an alarm is generated. This is helpful in searching a tape for the start of alarm events. Manually clearing an alarm (by pressing the Alarm button) resets this counter to 00.</p> <p>The Day/Night status will display "d" during Day mode settings, and "n" during Night mode settings. The green LED on the Day/Night button will also be lit during Day mode and will be off for Night mode.</p>

Video Loss

When video goes missing from the DS1-PL, a red warning background will be displayed with the message flashing "VIDEO LOST" in large characters. If the date-time information is enabled (see the On-Screen Data programming menu), the date and time when video went missing will be inserted under the "VIDEO LOST" message. This will warn an operator of the video loss condition and give the time and date of this occurrence. If the video is recorded to tape, the date and time will provide when the video loss had occurred.

After video has been restored, the DS1-PL checks its validity, then does a "cold boot" which restores the DS1-PL to its condition prior to video loss. See Section 9., Video Loss for programmig options for this function.

Programming the DS1-PL

To start programming, press the Program button. The Main Menu page will be displayed and the yellow LED will be lit on the Program button.

Main Menu

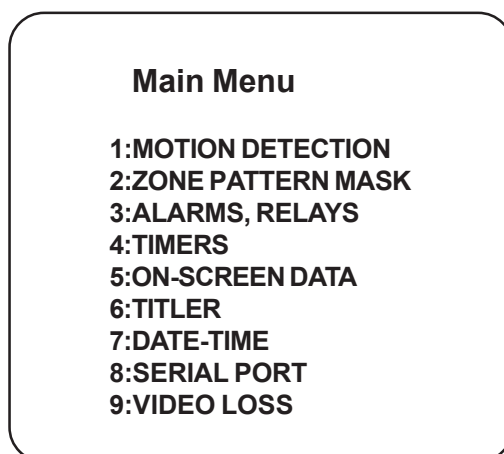

There are 9 items on the Main Menu. They itemize the main categories for setting the DS1-PL. From this menu, you branch to the menu page associated with each item where the setting is done.

- | | |
|-----------------------|--|
| Clear Button | Leave menu one level up or revert back to normal running operation if current page is Main Menu. |
| Menu Button | Sequences down through the Main Menu prompts. When it gets to the bottom, it wraps around to the top. An asterisk symbol highlights the selected item. |
| Left Button or | Selects the item in the Main Menu to program. The menu for the |
| Right Button | selected item is called up. |

1. Motion Detection Menu

This is the most important set-up for the operation of the motion detector. It is used to adjust criteria for qualifying a valid alarm. There are up to 8 areas which may be defined, and each of these areas has 3 criteria.

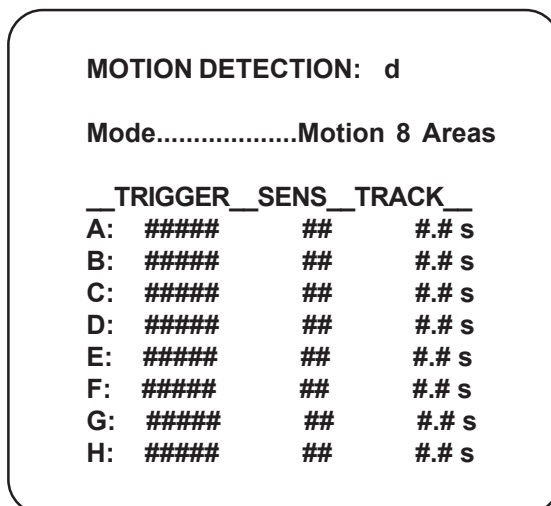

The top of the screen is the heading for this menu page, Motion Detection.

At the top right corner will be displayed “d” or “n” indicating you are programming the day or Night settings. Remember to toggle the Day/Night mode (the Day/Night button) prior to programming, to select the Day or Night settings.

The Mode Setting

The Mode setting defines the complexity of the DS1-PL, which is dependent on the scene from the camera. You may analyze up to 8 areas in the image, setting the criteria for each. Or you may want to analyze the direction of moving objects, etc. These are the options in the Mode setting.

- Off** This disables motion detection. However, alarms may still be triggered from an external source if you set the “External Input” prompt to “Alarms”.
- Motion - 1 Area** This sets up a single area to be analyzed for motion. For those familiar with the DS-1, it will perform the same in this mode.
- Motion - 2 Areas** Multiple area analysis for perspective or difficult lighting situations. Each area can have different criteria set to generate alarms. With 2 areas, one can be made foreground and the other background.
- Motion - 3 Areas** Same as above with 3 definable areas.
- Motion - 4 Areas** Same as above with 4 definable areas. This mode may be used for the DS1-PL to process a quad display.
- Motion - 5 Areas** Same as above with 5 definable areas.
- Motion - 6 Areas** Same as above with 6 definable areas.
- Motion - 7 Areas** Same as above with 7 definable areas.
- Motion - 8 Areas** Same as above with 8 (the maximum) definable areas.

Programming

Direction A>B...G>H This causes the DS1-PL to analyze motion moving in a particular direction and to generate an alarm when such an event occurs. Up to 8 areas are defined, being 4 “source” areas and 4 “destination” areas. Whenever an object moves from any “source” area to its associated “destination” area, an alarm is generated. Thus any direction can be defined by creating areas A and B, C and D, E and F, G and H in the Zone Pattern setups.

The sequence of events to satisfy direction qualification are:

- a) Motion in “source” area (A,C,E,G) above their trigger level with motion in “destination” area below the trigger level....then within the tracking time of “source” and “destination” areas.
- b) Motion in “destination” area (B,D,F,H) above the trigger level.

This timing of motion between “source” and “destination” areas may also be used to qualify motion by the speed of the moving object.

Motionless - 1 Area This causes the DS1-PL to analyze the defined area A, and if motion is less than the trigger level for the duration set by the tracking time, then an alarm is generated. The primary application is for industrial machine-vision installations where you would typically watch machinery such as a conveyor belt. If the conveyor belt stops moving, an alarm will be generated. Also, this mode may be used to determine if an area has been deserted of people, being an abnormal event.

Motionless - 8 Areas This causes the DS1-PL to analyze each defined area A-H, and if motion is less than the trigger level for the duration set by their tracking times, then an alarm is generated for this area. Anyalarm will also generate a global alarm output.

Museum Mode This mode causes the DS1-PL to check the amount of obscurity of areas defined by the Zone Pattern menu. If an object is removed from the defined area for the duration set by the tracking time, then an alarm is generated. Typical applications include monitoring pictures in a museum (hence Museum mode). Up to 8 works of art may be covered in this application.

NOTE

If museum mode is selected in operation . The track effect are Memory / S , Memory / A , Memory / AS will not available if these functions have been used then VMD will disable it automatically

PTZ Compatible Mode This mode is a special mode to disable the video motion detection function while a Pan-to-Zoom (PTZ) is in operation. Zones E,F,G and H are utilized for detection if the PTZ is in motion. This is done by looking for motion in 3 out of 4 of these preset zones. The trigger, tracking, and sensitivty of these reference zones can be programmed by the user for different applications. It is assumed that if 3 of the 4 zones have motion simlta neously then the entire camera view is changing and motion detection is disabled. The “Alarm Reset Time” is used here to time-out after the PTZ has stopped completely for video motion detection functions to be initiated. Zones A-D can be programmed as normal for motion detection.

Upon detection of a moving PTZ image, the DS1-PL will display the text “PTZ” in the bottom right-hand of the screen. This will indicate that the video motion detection is disabled and the unit is in the PTZ mode. After the PTZ has stopped and the relay hold time has expired, normal video motion detection fuctions will resume. This text display can be turned off by turning off the Status display via the on-screen programming.

Programming

NOTE

The zones E-H are fixed and the defineable area cannot be changed, only the motion parameters. It is recommended that the velocity setting be set at least half that of the normal zones but no times set for longer time than any detection zone.

The Three Motion Detection Criteria

Each of the areas up to 8 as indicated by rows A-H is set independently for detecting motion. There are 3 motion detection criteria for qualifying an alarm with respect to size, contrast from background, and duration of motion.

These 3 criteria, named Trigger Level, Sensitivity, and Tracking, are placed in 3 columns so they may be adjusted in a tabular type format where values may be compared to each other to simplify set-up.

Different parts of the screen, depending on distance from the camera, lighting conditions, shadows, etc., may be defined in separate areas using the zone pattern. Then the criteria should be adjusted to match the conditions to qualify an alarm.

The Trigger Level Setting

The Trigger Level setting is a threshold level, proportional to the size of the moving objects. The motion of objects generate "delta" (which can be observed on the video image if the Trace effect is turned on in the On-Screen Data menu page). The amount of delta is continuously compared to the trigger level, and an alarm is qualified if the motion exceeds this trigger level threshold for a duration (as defined by the tracking time).

Objects further from the camera generate less delta than objects close up. So if the defined area is in the background, you should reduce the **trigger level**.

There are 3 ways used to assist in setting up the **Trigger Level**.

Firstly, you may set the Status Display mode in the On-Screen Data menu to Area (A-H) Delta. This will display the actual delta count in the on-screen status display. This number is then used to estimate the size of the moving objects you want the motion detector to trigger. You then set the trigger level to that number. Each of the areas may be set accordingly.

Secondly, you may set the Status Display mode in the On-Screen Data menu to Alarm Flags. This will display the status information for all defined areas. After setting the trigger level, observe these status flags. If they change from a "-" (dash) to a letter a-h without sufficient motion, then you should increase the trigger level for that area. If the status flag remains a "-" (dash) with sufficient motion, then you should reduce the trigger level.

Thirdly, (and this comes with practice), you may calculate the desired trigger level. Each zone cell (there are 288 cells) has 432 pixels, or points, that are calculated for delta. If you estimate the size of the object you want to trigger as a ratio to the size of a zone cell and you multiply this by 432, this will give the number of pixels that the object will occupy in the image. This will be the ideal trigger level for that size object. Keep in mind, not all pixels bound by the moving object will generate "delta" pixels. This is because some moving objects will have some content of uniform shades of gray within the object, so these pixels do not generate "delta".

The Sensitivity Setting

The sensitivity setting is a contrast setting which discriminates the moving object from the background and also is a filter to reduce the effects of noise on the video signal. The values in the sensitivity setting are 0-99, where 0 is the least sensitive and 99 is the most sensitive. It is the level of deviation of the grayscale required to generate a "delta" pixel. The higher the sensitivity setting, the less the deviation required to generate "delta". This may sound confusing, so just remember, the higher the sensitivity setting, the more sensitive the video motion detector is to detecting moving objects.

You may observe the "delta" effect on-screen by turning on the Trace in the On-Screen Data set-up menu. This is helpful in setting up the sensitivity. If you want to reduce the effect of shadows triggering alarms, reduce the sensitivity, then again observe the "delta" effect to see if shadows are generating "delta" pixels.

If you see false "delta", which is normally produced by noise in the video signal, reduce the sensitivity setting and again observe the "delta" effect to see if the false "delta" has been eliminated.

In low contrast images such as misty or foggy conditions where the moving object blends in closely with the background, you will need to increase the sensitivity setting until sufficient "delta" is generated.

In most cases, however, the sensitivity can be left on 50%, the mid point.

The Tracking Time Setting

The tracking time measures the duration of motion to qualify an alarm. Whenever the amount of motion exceeds the trigger level, the defined areas are considered "triggered". If this triggered condition remains for a certain time then an alarm is qualified. This time is an adjustable setting and is called the tracking time because it is the time a triggered object is tracked.

The tracking time is the best way to reduce false alarms in outdoors scenes. This is because most natural motion from trees, insects, birds, etc. are erratic and their motion is not sustained long enough to qualify an alarm. A person however has more "intent", having a defined objective to move from point a to point b in a desired time. Objects moving with "intent" can therefore be separated from objects with little or no "intent".

Obviously when the object is further away from the camera it would take a longer time to traverse the image than if it were in the foreground. This can be used as an advantage to qualify distant motion by increasing the tracking time.

Other atmospheric conditions such as lightning are of very short duration (generally under one second) and these can be filtered out by keeping the tracking time to one second or more. If you do set the tracking time to 0, then effects such as these will qualify an alarm. So if you do want to detect lightning for instance on your local golf course, set the tracking time to 0.

Automobiles can cause alarms if they move in the defined area for the tracking time. If you do not want to trigger alarms on automobiles but only people, then you will need to reduce the tracking time by compromise. Knowing that people move slower than cars, estimate the minimum amount of time a person will move in the defined area and set the tracking time accordingly. The tracking time is adjustable in 1/10th of a second increments from 0 seconds to 5 minutes.

2. Zone Pattern Mask Menu

The Zone Pattern Mask Menu is used to divide up the image into separate areas or to mask-out areas where motion is analyzed or ignored.

There is a grid of 12 rows by 24 column zone cells. Any of these zone cells can be turned off (where motion will be ignored) or assigned to one of 8 areas A-H.

Programming

```
AAAAAAA   BBB   HHHHHH
AAAAAAA   BBBB  HHHHH
           BBBB  HHHH
CCCCCCCC  BBBB   HHH
CCCCCCCC           HHH
CCCCCCCCCCCCCCCCC   HH
                   CCCC  HH
DDDDDD           CCC  HH
DDDDDDDD           HH
EEEEEEEEEEEEEEEEEE   HH

FFF  GGGGGGGGGGGG   HHHH
FFF  GGGGGGGGGGGG   HHHH
```

Depending on how many areas are defined (A-H) in the Motion Detection set-up menu, this determines the maximum number of areas that can be generated by the Zone Pattern Mask menu. If only 3 areas are defined for example, then each zone cell can be either assigned OFF, A, B or C area. This area assigning will prevent areas greater than area C to be assigned.

```
AAAAAAA
AAAAAAA
AAAAAAA
AAAAAAA

           BBBBBBBB
           BBBBBBBB
           BBBBBBBB
           BBBBBBBB

CCCCCCCCCCCCCCCCC
```

The Cursor

A cursor is displayed in a zone cell which is a flashing letter A-H depending on the area it is over. All other letters will not be flashing. The cursor can be moved by pressing the Left or Right button keys. The cursor will change to a block while it is moving to make it easier to see. As the cursor moves over areas, it will not change the area assignments. It will simply flash A-H depending on the area it is over. If it is over an undefined area (or off area) a dot will flash.

Button Functions

Clear Button

Programming mode will terminate and the DS1-PL will return to Main Menu after saving the zone pattern into non-volatile memory.

Menu Button

The Area under the cursor will increase to the next area letter. If it was a B, it will become a C. Each time the Menu button is pressed, the area assignment will increase one at a time until area H (or the maximum possible). The next press will turn the area under the cursor off. If for example, 3 areas are defined in the Motion Detection menu, then the zone under the cursor will step A,B,C,off,A,B,C,off,A,B,C,off,.....etc.

Programming

Left Button This moves the cursor left one position. The cursor will flash the area letter assignment over the new area. If you hold the left button for longer than a second, then the cursor will move at a rate of 5 steps per second. While the cursor is moving it becomes a block to make it easier to see. When the cursor reaches the left most position on the line, it will wrap around to the right most position in the line above. If it is on the top line, it will wrap around to the bottom line.

Right Button This moves the cursor right one position. The cursor will flash the area letter assignment over the new area. If you hold the right button for longer than a second, then the cursor will move at a rate of 5 steps per second. While the cursor is moving it becomes a block to make it easier to see. When the cursor reaches the right most position on the line it will wrap around to the left most position in the line below. If it is on the bottom line, it will wrap around to the top line.

Menu+Left Button If you hold in the Menu button, then press or hold the left button, the cursor will move left (just like the left button), except the area assignment under the cursor is dragged and copied as it moves left. By doing this you can quickly paint in a contiguous area.

Menu+Right Button If you hold in the Menu button, then press or hold the right button, the cursor will move .

If during the zone pattern set-ups no buttons are pressed for longer than 2 seconds, then an alternative zone pattern screen appears. You may at any time go back to the original zone pattern screen by pressing the Menu button. This alternative zone pattern screen is used to quickly identify the area assignments. Its other purpose is to prevent the first zone pattern screen from obscuring the image behind it.

What is shown on this zone pattern screen is the zone pattern grid of 24x12 except the present area A-H (under the cursor) is replaced with flashing blocks. All other defined areas are replaced with dots and undefined (or off) areas are blank. The cursor will still indicate the present area as A-H with all other zone cells of the present area now being blocks.

Pressing the Left or Right buttons now flip through all areas, one at a time as blocks. This is an easy way to identify the areas defined, especially if complex layouts have been generated. Keep an eye on the cursor, which will display the area flipped.

The button functions for this zone pattern menu are as follows:

Clear Button Programming mode will terminate and the DS1-PL will return to Main Menu after saving the zone pattern into non-volatile memory.

Menu Button The original zone pattern menu will be restored, with all area assignments displayed as A-H.

Left Button This flips the present area, as displayed by the cursor to the next area, which is now displayed as flashing blocks. All other defined areas become dots.

Right Button This flips the present area, as displayed by the cursor to the next area, which is now displayed as flashing blocks. All other defined areas become dots.

3. Alarms, Relays Menu

```
ALARMS:                               d
-----
Buzzer.....ALARM
Relay Output.....ALARM
External Input.....OFF
Watchdog Timer .....OFF
Entrance Delay.....## s
Exit Delay.....## s
Alarm Process .....Time
Alarm Output Time.....## s
Alarm Reset Time.....## s
```

Programming

The top of the screen is the heading for this menu page, Alarms.

At the top right corner will be displayed “d” or “n” indicating you are programming the day or night settings. Remember to toggle the Day/Night mode (the Day/Night button) prior to programming to select the day or night settings.

The Buzzer Setting

Options: OFF, ALARM

The DS1-PL has an internal piezo buzzer which can be turned off or beep during alarm or motion conditions.

OFF The buzzer will not sound under any conditions. If you want the DS1-PL to be “silent”, be sure to turn the buzzer mode setting to OFF.

ALARM The buzzer will sound whenever an alarm output is generated by the DS1-PL. That is when motion has been qualified to generate an alarm. The buzzer will sound for the duration of the Alarm Output Time Setting (see below). This is the actual time an alarm contact is generated.

Relay Output Setting

Options: OFF, ALARM, PRETRIG, TIMER1, TIMER2, TIMER3, DAY/NGT

The universal form-C (NO, COM, NC) Alarm Relay generates contact closure and opening. These contacts are connected to the device such as a video recorder or alarm distribution panel. There are 3 “dry” contacts, normally-open, common, and normally closed, which are accessed by the back panel connector. Refer to the back panel diagram for these connection points.

The Alarm Relay can activate under various programmed conditions:

OFF The Relay will remain inactive under all conditions. Even if the DS1-PL qualifies an alarm, no operation of the relay will take place.

ALARM The Relay will activate whenever an alarm is qualified by the DS1-PL. The Alarm Relay remains activated for the duration of the Alarm Output Time Setting (see below). This is the most common for the alarm relay output mode setting.

PRETRIG The Relay will activate before an alarm is fully qualified. Whenever motion exceeds the trigger level in any defined area, the Relay will activate. This may be used as an early warning alarm output, to either warn an operator of a potential pending alarm or to start a recorder recording early, so that more alarmed footage may be recorded to tape.

TIMER1,2,3 The Relay will activate between the Start and Stop times of any of the 3 on-off timers. This may be used to turn equipment on and off such as lights, at different times of the day.

DAY/NIGHT The Relay will activate following the Day/Night mode of the DS1-PL. The relay will be active during Night mode and inactive during Day mode. The toggling of the DS1-PL's Day/Night mode can be done from the front panel, from the Day/Night timer if enabled, from an external input (see below), or from a serial RS-232 command.

External Input Setting

Options: OFF, ALM-AND, ALM-OR, ENABLE, DISABLE, DAY/NGT, CAP REF

An input signal to the DS1-PL may be used to control the DS1-PL in various ways. A closure to ground activates this signal, so it may be in the form of a loop-closure switch to ground, a TTL level low, or a closure to ground from an external device (in this case both the DS1-PL's ground and the equipment's ground needs to be commoned).

The various modes of this external input contact are set with this prompt to provide the following actions:

- OFF** The DS1-PL takes no action on the external input whether it be open or closed to ground.
- ALM-AND** The DS1-PL combines alarms from external equipment (or another DS1-PL) such that an alarm is output when the DS1-PL qualifies an alarm and the external equipment generates an alarm. This is used as a redundancy-verification system to double-check the validity of an alarm. This mode may also be used as a 3D-triangulation method of detecting motion in 3D space. If 2 DS1-PL's are used with their cameras looking perpendicularly at a scene with the first DS1-PL's alarm output connected to the External Input of the second DS1-PL, then the second DS1-PL will generate an alarm whenever motion occurs at the intersection of both DS1-PL's zoned areas.
- ALM-OR** The DS1-PL combines alarms from external equipment (or another DS1-PL) such that an alarm is output when the DS1-PL qualifies an alarm or the external equipment generates an alarm. This is used as a redundancy-safety system, to generate an alarm condition, from one of many events. If 2 DS1-PLs are used with the first DS1-PL's alarm output connected to the External Input of the second DS1-PL, then the second DS1-PL will generate an alarm whenever qualified motion occurs from either camera. This can be used in heavy industry where stamping presses need to be turned off whenever a person moves into any area where they may be harmed.
- ENABLE** The DS1-PL is enabled whenever this signal is active (a closure to ground). You may use this to gate the operation of the DS1-PL on and off. For example, this may be used to enable the DS1-PL only when a door is closed by using a door contact which makes a contact closure when the door is closed.
- DISABLE** The DS1-PL is disabled whenever this signal is active (a closure to ground). You may use this to gate the operation of the DS1-PL on and off. For example, this may be used with a PTZ controller to disable the DS1-PL whenever the camera moves, then enable the DS1-PL again when the camera stops moving.
- DAY/NGT** The DS1-PL can be switched between the day and night settings with the External Input. When the External Input is active (closure to ground), the DS1-PL will switch to the Night mode settings, and when this signal becomes inactive the DS1-PL will switch to the Day mode settings.
- CAP REF** In the Museum mode, the DS1-PL compares the live image from the camera to a freeze frame image stored in memory to determine the obscurity of the areas it is processing. Normally this freeze frame reference image is captured automatically at the end of the programming of the DS1-PL. You may want to capture this reference image at any time later, you can do this by setting this mode. The reference image will be captured when the External Input makes a closure to ground.

Watchdog Timer

Options: ON, OFF

The internal watchdog timer is in continuous operation whether this setting is ON or OFF. If for some reason the uP stops for more than 250ms, the internal counter is automatically timed-out and issues a reset to the uP to continue operation.

When this option is selected ON, the watchdog timer signal is output to Zone Alarm H. This output is continuously toggled ON and OFF at a period of 250ms. If for some reason this signal is not periodic, the uP has ceased to operate from a hardware failure. When this option is set OFF, the watchdog output is not sent to Zone Alarm H and this alarm function is normal.

Entrance Delay Setting

Options: 0-99 seconds

The entrance delay is the delay which occurs the first time the DS1-PL qualifies an alarm (after being manually enabled) to the time it generates its first alarm output. This will give the user the opportunity to enter the premises without generating an alarm. Most domestic alarm systems have this feature. The Entrance Delay can be programmed to between 0 and 99 seconds. If it is set to 0, then the DS1-PL will generate an alarm immediately after the the first motion has been qualified.

Exit Delay Setting

Options: 0-99 seconds

The exit delay is the delay which occurs after the DS1-PL has been manually enabled (by pressing the Alarm button) to the time it starts processing motion to qualify an alarm. This will give the user the opportunity to exit the premises before an alarm is generated. Most domestic alarm systems have this feature. The Exit Delay can be programmed to between 0 and 99 seconds. If it is set to 0, then the DS1-PL will start to process alarms immediately after the DS1-PL has been enabled.

Alarm Process

Options: *Time or Retrigger*

The Time mode is defined as a fixed period of time from when the alarm is initiated. After the programmed time period, the alarm is stopped and can not be reset until the Alarm Reset time has elapsed. If multiple alarms occur within the Time mode, they are ignored and the time starts from the initiation of the first alarm.

The Retrigger mode starts the programmable time from the last alarm occurrence within the dwell period. If an alarm occurs and is reset within the programmed alarm time and a new alarm occurs, the programmed alarm time is reset and the process occurs indefinitely until no alarms occur within the programmed time period.

Alarm Output Time Setting

Options: *Man 0-99 seconds*

The Alarm Output Time is the time an alarm is actively output to the relay contacts. The buzzer will also sound for this duration if it has been set to Alarm mode. The alarm will stay active for this time and no further processing of motion will take place until it has timed-out. If motion continues when it has timed-out, the alarm output time will be extended to the point where motion no longer exceeds the trigger level set. One second should be an adequate setting in most cases because video recorders have their own recording time setting, and video switchers and matrix switchers have their own alarm dwell time settings. If the Alarm Output Time is set to Man (Manual). Alarms will generated following VMD.

Alarm Reset Time Setting

Options: 0-99 seconds

This is the minimum time between alarms generated by the DS1-PL. This is a means to stretch out alarm events. For instance, if you are using the DS1-PL to trigger a video printer, you want one picture when an alarm event occurs but not hundreds of pictures of each event. At the end of the alarm output when the relay drops out, the DS1-PL will reset itself and stay reset for this duration before the next alarm is qualified.

4. Timers Menu

The DS1-PL has 3 independent on-off timers used to enable/disable motion detection, and one day/night timer to toggle between 2 banks of user's settings called Day and Night.

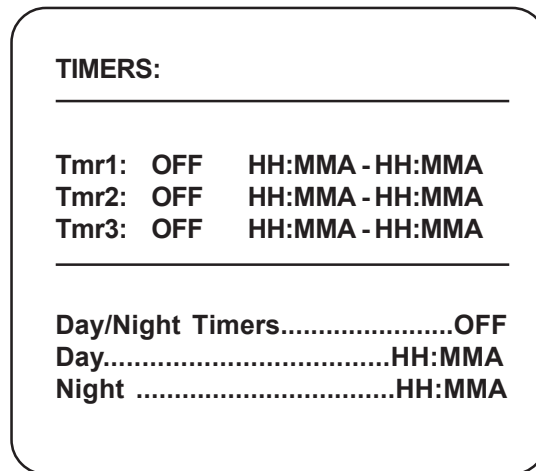

The top of the screen is the heading for this menu page, Timers.

The 3 On-Off Timer Settings

Each of the 3 timers are set independently. Each has a mode and a Start and Stop time.

The mode, which is the first setting (on the left), determines if the timer is turned on and which day(s) of the week the timer will be active. The DS1-PL alarm will be enabled on this day(s) between the set Start and Stop time.

Mode Options: OFF, SUN, MON, TUE, WED, THU, FRI, SAT, M-F, M-S, S-S, ALL

This selects if the timer is either Off, is a specific day of the week (Sunday through Saturday), or is a combination of days.

- M-F is Monday through Friday
- M-S is Monday through Saturday
- S-S is Saturday and Sunday (weekend)
- ALL is every day of the week

Programming

Start and Stop Times

On the day(s) of the week selected, the DS1-PL will be made enabled during the Start and Stop times. The first time, displayed as HH:MMA, is the hour, minute, and AM/PM that the DS1-PL will become enabled. This is the Start time.

The second time, displayed as HH:MMA, is the hour, minute, and AM/PM that the DS1-PL will become disabled. This is the Stop time. If the Stop time is earlier than the Start time, then the DS1-PL will become disabled on the following day.

For example:

Tmr1: TUE 4:00P - 8:00A will enable the DS1-PL from 4 PM on Tuesday to 8 AM on Wednesday.

Note

If a timer is turned Off, then the Start and Stop times will have no effect.

By combining up to 3 On-Off timers, many combinations of enabling/disabling of the DS1-PL can be achieved. The times and days of the timers may be separated or may even be overlapped. When more than one timer is on, then motion detection will be enabled when any timer is between its Start and Stop time. The motion detector will be disabled when all timers have reached their stop times. The examples that follow will show how this works.

Timer Examples

Example 1

Enable motion detection every day between 8 AM and 5 PM.

Tmr1: ALL 08:00A - 05:00P

Tmr2: OFF

Tmr3: OFF

Example 2

Enable motion detection every day between 7:30 PM and 8:45 AM.

Tmr1: ALL 07:30P - 08:45A

Tmr2: OFF

Tmr3: OFF

Example 3

Enable motion detection every weekday in the mornings between 6 AM and 6:30 AM, and in the afternoons between 4:30 PM and 5:10 PM.

Tmr1: M-F 06:00A - 06:30A

Tmr2: M-F 04:30P - 05:10P

Tmr3: OFF

Programming

Example 4

Enable motion detection every Saturday between 9 AM and 4 PM, every Sunday between noon and 3 PM, and every weekday between 7 AM and 6 PM.

Tmr1: SAT 09:00A - 04:00P

Tmr2: SUN 12:00P - 03:00P

Tmr3: M-F 07:00A - 06:00P

Example 5

Enable motion all Friday.

Tmr1: FRI 12:00A - 11:59P

Tmr2: OFF

Tmr3: OFF

Example 6

Enable motion detection every weekday between 9 PM and 5:30 AM and every weekend between 7 PM and 10 PM.

Tmr1: M-F 09:00P - 05:30A

Tmr2: S-S 07:00P - 10:00P

Tmr3: OFF

Example 7

Enable motion detection on Tuesday at 7 AM, at 8 AM, and at 9 AM for 5 minutes each.

Tmr1: TUE 07:00A - 07:05A

Tmr2: TUE 08:00A - 08:05A

Tmr3: TUE 09:00A - 09:05A

Example 8

Enable motion detection every day between 6 AM and 7:30 PM except Fridays which should be between 5:30 AM and 9 PM.

Tmr1: ALL 06:00A - 07:30P

Tmr2: FRI 05:30A - 09:00P

Tmr3: OFF

Programming

The on-off timers are a way to fully automate the generation of alarms. Once the timers have been set, the DS1-PL needs no further intervention. If you do not want an automated (by time) DS1-PL, then be sure to turn all the timers off. In this way, you can enable or disable alarming from the front panel using the alarm button as an enable/disable toggle.

you are using a timer (or timers) to enable/disable the motion detector, you may still override the enable/disable function from the front panel, but at the next Start or Stop time of the timer, the timer will take control again of enabling/disabling. After you set the timers you may wish to manually disable motion detection from the front panel, then walk away and let the timers take control from that point. You may observe the timers kicking in and out of operation by watching the status indicators. When the DS1-PL is enabled, the red LED will be lit above the Alarm button. Also, the Alarm status on-screen will display "A" (uppercase) when enabled, and "a" (lowercase) when disabled.

The Day/Night Timer Settings

The Day and Night modes of the DS1-PL are 2 independent banks of the user's settings which contain all the settings of the DS1-PL where you may have different zone patterns, sensitivities, and buzzer on/off, etc.

The purpose is to quickly switch between these settings for different conditions. It will most likely used for switching between motion criteria for detecting motion in the day and at night. However, the day and night settings may be used at any time of the day or night when the user wants to switch between 2 programmed banks of settings.

The Day/Night timer can be used to automate this switching between day and night settings. There are 2 modes, On and Off. Turn the Day/Night timer On if you need to use it and Off if you want to manually switch between Day/Night modes by using the Day/Night toggle button on the front panel.

There are 2 times that are set. The first is the Day switchover time and the second is the Night switchover time. The format is the same as the On-Off timers: **HH:MMA** This sets the hours, minutes, and AM/PM for the Day or Night switchover times.

At the time of the day's switchover time, the DS1-PL will use the "day" settings. Also, the green LED will be lit and the day/night status indicator on screen will display "d".

At the time of the night's switchover time, the DS1-PL will use the "night" settings. Also, the green LED will be off and the day/night status indicator on-screen will display "n". The Day/Night timer works independently of the 3 On-Off timers. So while the On-Off timers are enabling/disabling the motion detection, the day/Night timer will load the Day or Night settings.

You may use the Day/Night timer as a 4th On-Off timer if you need by turning on motion in the Day settings (mode setting in the Motion Detection menu), and turning it off at night, or visa versa.

5. On Screen Data Menu

The DS1-PL displays overlaid on the video image various information to be observed or recorded to tape. It is used mainly as status information pertaining to the image being analyzed. There are various items such as date and time and camera titler, or black screen or “delta” effects, and each of these may be turned on or off or placed in various modes of display. None of these settings affect in any way the performance of the motion detection. They are only there for the benefit of enhancing the information provided to the user.

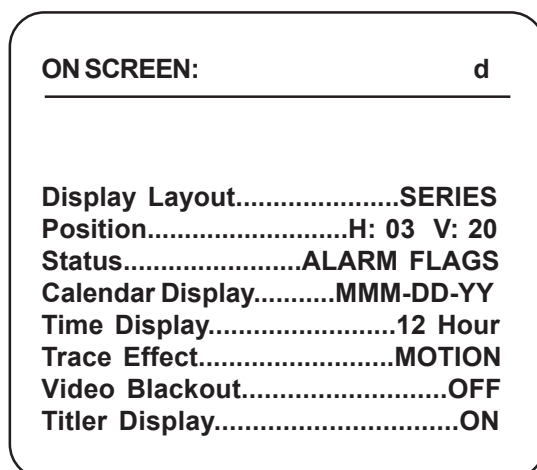

The top of the screen is the heading for this menu page, On Screen.

At the top right corner will be displayed “d” or “n” indicating you are programming the day or night settings. Remember to toggle the Day/Night mode (the Day/Night button) prior to programming to select the day or night settings.

The Layout Setting

Options: OFF, STACKED, SERIES

The DS1-PL has 2 different ways the on-screen information is displayed (such as date, time, titler, etc). This is set so that the image behind it is not obscured.

OFF No on-screen information is displayed. This is a way to globally turn all the on-screen information off so that the camera’s video is all that is seen on the monitor.

STACKED The on-screen information is displayed in a tall and narrow format of up to 5 lines of text high and of 9 characters across.

SERIES The on-screen information is displayed in a short and wide format of up to 2 lines high and of 24 characters across.

The Position Settings

Options: Horizontal: 1-12, Vertical: 1-22 (NTSC) or 1-27 (PAL)

The on-screen information can be shifted to any part of the screen by setting the values in the horizontal and vertical settings.

Horizontal is the left to right positioning of the display. The higher the number, the more to the right the

Vertical is the top to bottom positioning of the display. The higher the number, the more to the bottom the display will be.

Programming

Typical settings are:

Horizontal: 3, Vertical: 3 (for the top left corner)

Horizontal: 3, Vertical: 20 (for the bottom left corner)

Lining up the on-screen display to the top or bottom right corners depends on the stacked or series settings because this defines the shape of the layout information.

The Status Setting

Options: OFF, AREA # DELTA, ALL DELTA, ALARM FLAGS

The DS1-PL has 2 different ways the on screen information is displayed (such as date, time, titler, etc). This is set so that the image behind it is not obscured.

OFF No on screen status information is displayed. This turns off the 8-character position status indicators, as well as the alarm status display, alarm counter display, and day/night status display.

AREA # DELTA The delta for a specific area A-H can be displayed. This indicates the number of pixels which have moved in that area, as defined in the zone pattern setups. The higher the number, the larger is the moving object. No motion will indicate 0 (zero pixels moving). You may use this setting to assist in setting up the trigger level for a specific area.

ALL DELTA The delta for all defined areas A-H can be displayed. This indicates the number of pixels which have moved in all defined areas. The higher the number, the larger is the moving object. Any motion in any area will generate a number indicating the number of pixels.

ALARM FLAGS This is probably the most informative status display. It indicates the status of each area by using symbols to indicate their status. For each area A-H:

- 1) a dot represents no motion (or even noise) is present.
- 2) a dash represents any motion not exceeding the trigger level.
- 3) a lower case letter (a-h) represents motion exceeding the trigger level.
- 4) an upper case letter (A-H) represents motion exceeding the trigger level for a sustained period of time as set in the tracking time setting. This also shows when an alarm is qualified. The DS1-PL will generate an alarm output condition if any upper case (area) is displayed.

The Calendar Display Setting

Options: OFF, MMM-DD-YY, YY-MMM-DD, DD-MMM-YY

The month, date, and year display may be turned off or displayed in various international modes which change the order of this data. This setting is only for on-screen information, so does not affect the internal clock used for timers and logging functions. The calendar format is used for date-time generation and the same setting is also used in the Log display.

OFF No on-screen calendar information is displayed.

MMM-DD-YY Month, then date, then year (USA).

YY-MMM-DD Year, then month, then date (Canada, Japan).

DD-MMM-YY Date, then month, then year (Europe, Asia).

The Time Display Setting

Options: OFF, 12 hour, 24 hour

The hours, minutes, and seconds display may be turned off or displayed in 2 formats. This setting is only for on-screen information so does not affect the internal clock used for timers and logging functions. The time format is used for date-time generation and the same setting is also used in the Log display as well as the setting page for timers.

OFF: No on-screen time information is displayed.

12 hour Hours (1-12) , minutes, seconds, and AM/PM status (A or P).

24 hour Hours (00-23) , minutes, seconds

The Trace Effect Setting

Options: OFF, MOTION, MEMORY, MEMORY/F, MEMORY/S, MEMORY/A, MEMORY/AS

The DS1-PL calculates motion on the pixel level. Each pixel is calculated for motion independently. Any pixel that exceeds the sensitivity threshold can be displayed on-screen. These appear as little highlighted dots called the “delta” display or “trace effect”.

These dots appear to surround moving objects or follow the trajectory of moving objects when they are accumulated in the “memory” modes.

OFF: No on-screen time trace effect is displayed.

Motion Trace effect continuously updates frame by frame, normally seen as high lighted pixels surrounding moving objects.

Memory Trace effect is accumulated, which highlights areas in the image where motion has taken place since last cleared. The trace memory may be cleared manually by pressing the Alarm button or automatically at the end of the alarm timeout. If the alarm is disabled, the trace will continue accumulating. This feature is used to display the history of past motion activity or display the trajectory of moving objects. The trace memory highlights the pixels affected so the image becomes brighter in these areas, so the image is still seen.

Memory/F Trace effect, same as above, except flashed on and off the screen 2 times per second. This may be used when the trace memory obscures the background video image too much.

Memory/S Same as Memory Function, but this function will show trace effect in strobe effect at 2 Hz.

Memory/A Same as Memory Function but the memory on-screen starts after the motion alarm has occurred.

Memory/AS This is the same as Memory/S but the memory strobe mode starts after the motion alarm has occurred.

Note

Memory /S, Memory /A, and Memory / AS are not available in museum mode . If these function have been selected.The VMD will disable it automatically.

TRACE "MEMORY"

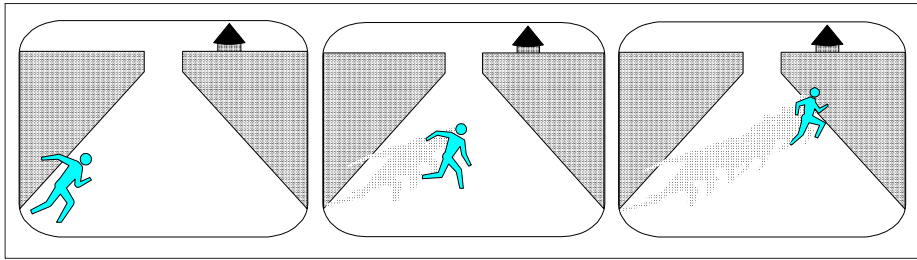

Figure 4 : TRACE "MEMORY"

TRACE "MEMORY"

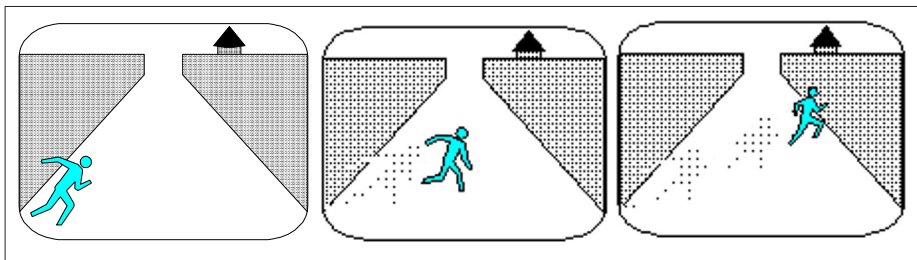

Figure 5 : TRACE "MEMORY"

BLACKOUT "ON" & TRACE "ON"



Figure 6 : BLACKOUT "ON" & TRACE "ON"

BLACKOUT "AUTO"

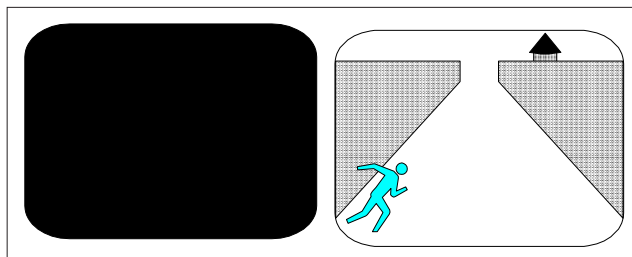

Figure 7 : BLACKOUT "AUTO"

The Video Blackout Setting

This setting allows for the entire screen to be black so no video view of the camera can be seen. If the trace motion is enabled, you will see the white trace outline on the black video background.

Options: OFF, ON, AUTO

OFF Normal video screen operation.

ON The entire video screen will be black with the exception of the on-screen data and the trace effect if enabled.

AUTO The entire video screen will be black with the exception of the on-screen data and the trace effect if enabled until an alarm is detected. When this occurs the video screen will switch back to the normal video view. The normal view will remain until the alarm is reset.

The Titler Display Setting

Options: OFF, ON

The 16-character camera titler may be turned on or off. The titler may also be turned off by making all the characters a "space", but this is an easier way to do it.

OFF No on-screen camera titler is displayed.

ON The camera titler is displayed. A different titler message may be used for day and night settings to indicate different conditions or to identify the operators name or what the camera is looking at, etc.

6. Camera Titler Menu

The Camera Titler is a means of writing a message onto the video image, to identify the camera, or for any other information you wish to put there. It is a text message of 16 character positions which may consist of any mix of alpha characters (A-Z), numeric characters (0-9), and special characters (such as periods, commas, spaces, etc.).

The titling information along with the Date and Time information is recorded on the tape. It is used mainly as status information pertaining to the image being analyzed. There are various items such as date and time, and camera titler, or black screen or "delta" effects, and each of these may be turned on or off or placed in various modes of display. None of these settings affect in any way the performance of the motion detection. They are only there for the benefit of enhancing the information provided to the user.

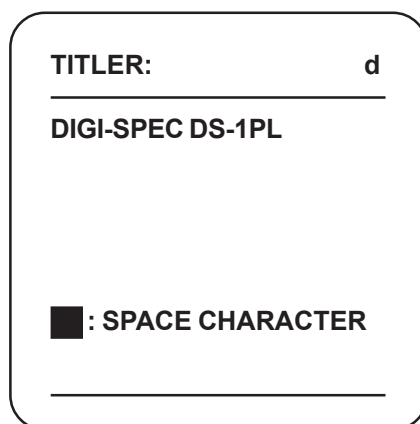

The top of the screen is the heading for this menu page, Titler.

At the top right corner will be displayed "d" or "n" indicating you are programming the day or night settings. Remember to toggle the Day/Night mode (the Day/Night button) prior to programming to select the day or night settings.

The Titler Settings

Press the MENU button to sequence through all 16 positions. If you overstep a position, the prompt will wrap around from the end to the beginning again. A flashing prompt will indicate which character is being set. Press the left or right buttons to sequence forwards or backwards through all available characters until the desired character is reached. A space character is displayed as a flashing block.

7. Date-Time Menu

The Date-Time Menu is used to set the clock of the DS1-PL. The clock is used for the following functions:

- 1) On-Screen Date-Time Generator (this may be turned off in the On-Screen menu)
- 2) On-Off Timers
- 3) Day/Night Timer
- 4) Alarm Logging

The clock will keep time if the DS1-PL is powered down for as many as 3 days by using power from an internal "SuperCap". You will need to set the clock if the unit is powered down for longer than this period. The clock should maintain accuracy within less than 7 seconds per month depending on the ambient temperature.

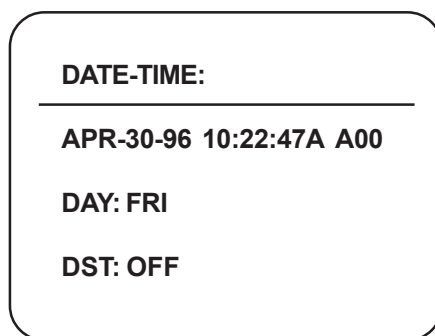

The top of the screen is the heading for this menu page, Date-Time.

In this menu, the preset date and time information, alarm counter, and day of week is displayed. This screen can be called up independently of day/night settings.

The Date Time Settings

Clearing The Alarm Counter

There are 9 prompts associated with this set-up screen and they sequence in the order displayed:

MMM	Month displayed as (JAN, FEB, MAR,..... NOV, DEC)
DD	Date (1-31)
YY	Year (00-99). Note: the year 2000 is 00
HH	Hours (1-12 with AM/PM, or 00-23, depending on 12/24 format chosen on the On-Screen menu set-up)
MM	Minutes (00-59)
SS	Seconds (00-59)
A00	Alarm Counter (00-99) -Can clear this number by selecting and setting to 00
DAY	Day of the week (SUN, MON, TUE,..... FRI, SAT) requires setting if you use the timers.

Programming

DST Daylight Saving Time (OFF, USA, CANADA). This mode automatically adjusts for daylight saving time, a 1-hour decrease in the Fall and a 1-hour increase in the Spring.

- | | |
|---------------|--|
| USA | - Last Sunday of October after 2:00 a.m. (-1 hr) |
| | - First Sunday of April after 2:00 a.m. (+1 hr) |
| Canada | - Last Sunday of October after 12:00 a.m. (-1 hr) |
| | - First Sunday of April after 12:00 a.m. (+1 hr) |

8. Serial Port Menu

The DS1-PL has a RS-232 interface to receive and transmit data from a PC or a serial printer or any other peripheral device that will accept RS-232 data.

The serial input may be used to set up the DS1-PL to alter settings. Software named PLSETUP.EXE will run on a PC to configure the DS1-PL remotely from the PC. Refer to the Serial Protocol Section for details.

The serial output generates various status information which may be captured on a PC or printed to a serial printer. A serial/parallel converter box is required if the printer has a parallel (Centronics) interface.

The pins on the female DB-15 connector used for serial communication are:

- | | | | |
|----|-------|---------------|---------------|
| 12 | ----- | Ground | (Common) |
| 13 | ----- | Transmit Data | (from DS1-PL) |
| 14 | ----- | Receive Data | (to DS1-PL) |

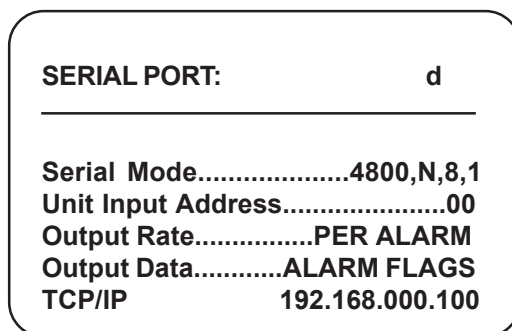

The top of the screen is the heading for this menu page, Serial Port.

At the top right corner will be displayed “d” or “n” indicating you are programming the day or night settings. Remember to toggle the Day/Night mode (the Day/Night button) prior to programming to select the day or night settings. The baud rate and address are the same for the Day mode and Night mode. If you change in one mode, the other will change automatically.

The Mode Setting

Options: 1200, 2400, 4800, 9600, 19200, 28800

These are the baud rates available for communication with the DS1-PL. The mode is fixed at 8 data bits, no parity, and 1 stop bit. The DS1-PL may, however, receive 2 or more stop bits.

The Address Setting

This sets the address of the unit for the serial communications. This allows the RS-232 data to all units to be in parallel and only accept commands if the correct address is selected.

Options: 0-127

Programming

The Output Rate Setting

Options: OFF, PER ALARM, CONTINUOUS

The data rate setting configures the rate at which the DS1-PL outputs data.

OFF No serial data is transmitted by the DS1-PL. Serial data may still be received.

PER ALARM The serial data is sent at the start of each alarm generated by the DS1-PL, so data may be “stretched out” over time by increasing the Alarm Output Time setting in the Alarms menu.

CONTINUOUS The serial data is sent each and every frame of video, which consists of single bytes or packets of information every 1/30th second in NTSC (1/25th sec in PAL).

NOTE: When you select the UDP Mode below the data is only sent out once every 5 seconds. However when an alarm occurs the data is sent out at that time also immediately.

The Output Data Setting

Options: MOVE FLAGS, TRIGGER FLAGS, ALARM FLAGS, STATUS FLAGS, ALL FLAGS, AREA # DELTA, ALL DELTA, ALARM LOG, UDP

The data setting configures the type of information the DS1-PL sends.

MOVE FLAGS Any motion or noise. Eight area bit-mapped

TRIGGER FLAGS Any motion exceeding the trigger level. Eight area bit-mapped.

ALARM FLAGS Any area qualified alarm. Corresponds to the 8 area relay outputs. Eight area bit- mapped.

STATUS FLAGS Various status information of the present condition of the DS1-PL, including common alarm, enabled, day/night etc.

ALL FLAGS Combination of the 4 flags with a header byte.

AREA # DELTA Number of pixels triggered (delta pixels) in a selected area A-H. Two bytes binary number (64k) with a header byte.

ALL DELTA Number of pixels triggered (delta pixels) in all selected areas A-H. This is full screen delta. Three bytes as above, saturated to 64K.

EVENT LOG This transmits the date and time and areas (A-H) under alarm. All ASCII characters, followed by a CR, LF. This is mainly used for alarm log printout. Also, in this mode, data is output once per alarm, independent of the above rate setting.

UDP This selects the protocol UDP (Universal Data Protocol) that is used to communicate to the Ethernet LAN adapter. When selecting this function and using with the DigiSpec LAN adapter data sent when the “Continuous” Output Rate is selected is the data is only output once every 5 seconds. However when an alarm occurs the data is sent out at that time also immediately.

In this format the data output contains the following information:

- Zones Selected A-D, E-H truncated
- Date and Time
- Move Flags A-H
- Trigger Flags A-H
- Alarm Flags A-H
- Status - Day/Night, Alarm Disable/Enable, Video Ok/Lost

Additional informaton on the display of this data review the DSVMD Software manual or Appendix E Serial Protocol

TCP/IP

When used with the optional Ethernet LAN adapter the DS1-PL can be used to set the IP address of this adapter from the on-screen menu. The Output Data must be set to "UDP" and the proper cabling connection made from the DS1-PL serial port to the LAN adapter serial port. The LAN adapter can also be programmed directly from a PC serial port if desired using the DSVMD software and proper cable. You may also program the DS1-PL directly via a PC and serial port and set the TCP/IP settings along with all other DS1-PL settings. See Appendix B Page 39 for additional information.

9. Video Loss

The option selects how the video loss alarm performs.

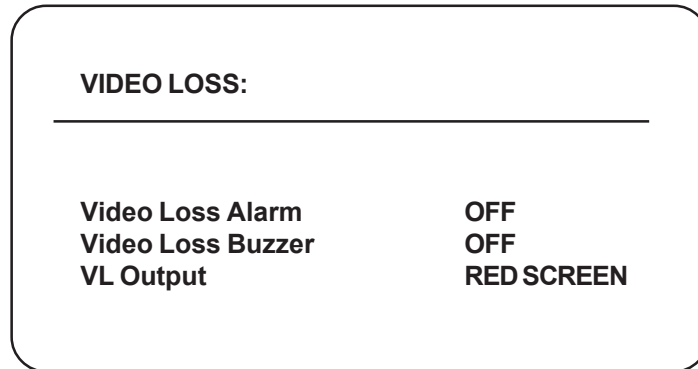

Video Loss Alarm

Options: ON, OFF

OFF When this option is turned off, the relay output does not close upon a video loss alarm.

ON When turned on, the relay will close upon a video loss occurrence and function under the settings of alarm output and reset times.

Video Loss Buzzer

Options: ON, OFF

OFF Does not allow the buzzer to sound upon video loss.

ON Allows the buzzer to sound upon video loss.

VL Output

Options: RED SCREEN, VIDEO

RED SCREEN When selected, the video output of the DS1-PL is an internally-generated RED SCREEN with the Time and Date of the video loss occurrence. This Red Screen is actually a composite video signal and devices in series with the DS1-PL will see a valid video signal.

VIDEO When selected, the input video is passed through the DS1-PL continuously whether in a video loss condition or normal condition. This will allow devices in line with the DS1-PL to continue to record or to make their own decision if video is lost or not.

10. Master Reset

To reset the entire unit to the factory defaults, do the following:

- Power down the unit.
- Press and hold the “Alarm Clear” button.
- Power up the unit while continuing to hold the “Alarm Clear” button for 3 seconds.
- The unit will revert to the factory default settings and all user programming will be erased. The Date/Time will, however, still be the current setting.

Note

Additional information regarding applications and technical issues can be found on the DigiSpec web site: www.digispecvideomotion.com

APPENDIX A

DS1-PL Feature / Alarm Connector

DB-15 Female Connector

Pin#	Function:
1	Alarm Area A (these are closure to ground)
2	Alarm Area B
3	Alarm Area C
4	Alarm Area D
5	Alarm Area E
6	Alarm Area F
7	Alarm Area G
8	Alarm Area H
9	N/C (normally closed) Universal Alarm
10	N/O (normally open) Universal Alarm
11	COM (common) Universal Alarm
12	GROUND
13	RS-232 Serial Output
14	RS-232 Serial Input
15	External Contact Input

Table 2 : DB-15 Female Connector

DS1-SPL Feature / Alarm Connector

20 Pin Male Box Header

Relay NO (Normally Open)	1	2	-Relay NC (Normally Closed)
Alarm Out (Active Low 5VDC)	3	4	Relay Common
Serial Date In	5	6	Alarm Input
N/C	7	8	N/C
GND	9	10	GND
Video Out	11	12	Video Out
GND	13	14	GND
Video In	15	16	Video In
GND	17	18	GND
VCC (5 VDC)	19	20	VCC (5 VDC)

Table 3 : 20 Pin Male Box Header

Ethernet LAN Adapter

The Ethernet LAN adapter allows for the DS1-PL to be operated on any common LAN network. The adapter connects to the DS1-PL Serial port and its IP can be set via the on-screen menu of the DS1-PL. When used with conjunction with our DSVMD Software for Windows you can fully operate and program the DS1-PL remotely. Additional features like uploading, downloading, and saving configurations are also possible. This software also supports direct serial connection to the DS1-PL and IP direct programming of the LAN adapter via a PC or laptop.

Additional windows can be opened for simulating the front panel keypad, view alarm status and read the data packet of the alarm conditions. The data on the LAN is in the UDP format and can coincide with TCP/IP and other LAN based networks simultaneously.

LAN and DSI-PL Connections

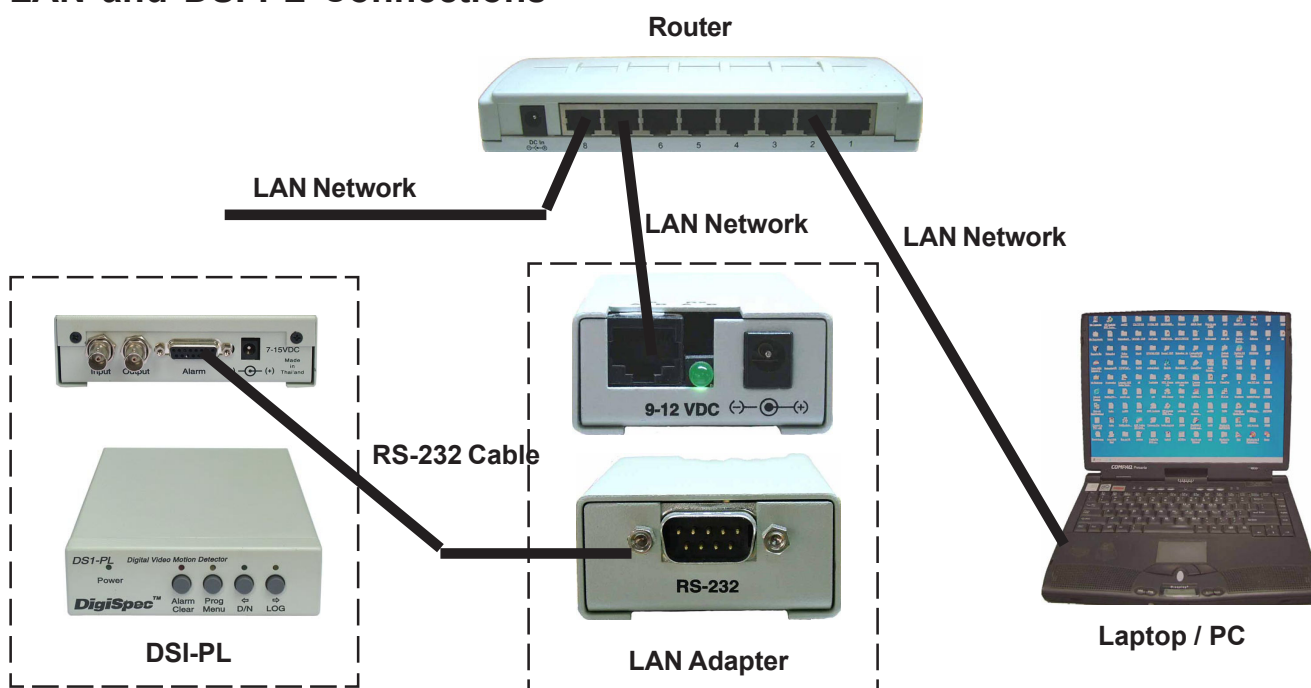

Figure 8: LAN and DSI-PL Connections

Appendix C - Cable Pinouts

The following cable is for connection from the DS1-PL to the LAN adapter or from a PC to the DS1-PL for serial programming.

LAN Adapter or PC DB9 Female	DS1-PL DB15 Male
2 (RXD)-----	13 (TXD)
3 (TXD)-----	14 (RXD)
5 (GND)-----	12 (GND)

Table 3: LAN Adapter or PC to DS1-PL

LAN Adapter DB9 Female	PC DB9 Female
2 (RXD)-----	3 (TXD)
3 (TXD)-----	2 (RXD)
5 (GND)-----	5 (GND)

Table 4: LAN Adapter to PC

The following cable is for the connection from the DS-16 to the LAN adapter or from a PC to the DS-16 for serial programming.

Note: The DS-16 is only one way communication and can not upload or reply any status to the LAN adapter or PC.

LAN Adapter or PC DB9 Female	DS-16 DB25 Female
2 (RXD)-----	3 (TXD)
3 (TXD)-----	2 (RXD)
4 (DTR)-----	4 (DTR)
5 (GND)-----	7 (GND)

Table 5: LAN Adapter or PC to DS-16

The cable pin out to the left is for direct programming of the LAN adapter via a serial port of a PC or Laptop.

DSVMD Software

Installation

Place the included CD-ROM in your drive and should open with menu selections. If it does not open then select “Explore” of the CD-ROM and double click on the “Setup.exe” file in the software directory. It will look similar to the following “E:\Software\DSVMD\Setup.exe”. When the installation of the software is finished, then run DSVMD software from your Program Menu.

Opening Window

Figure 9: Software Select Window

Select Software

“**DSVMD - Serial**” - This selection allows you to directly connect to the DS1-PL via a serial connection from your PC. The appropriate cable must be connected to a powered up DS1-PL and the connection will be made. If a proper connection is not made you still can run the program in the off-line mode, save your settings and later connect.

“**Dsvmd - UDP**” - This selection allows you to connect to the DS1-PL via the Ethernet LAN adapter. The proper IP address must be programmed into the LAN adapter. This can be done by the on-screen menu of the DS1-PL while the LAN adapter is connected to the DS1-PL or via the IP Address Setting function below. Then make sure your LAN adapter is connected to the network and connected to the DS1-PL.

“**IP Address Setting**” - This selection allows you to directly connect the serial port of the PC to the LAN adapter. You then can program the IP address directly into the LAN adapter. The IP address is stored in non volatile memory so will never be lost.

Serial Connection

Figure 10: Setting Window

Setting;

Format NTSC or PAL - Select the proper format for cameras you are using

System DS1-PL or DS-16 - Select the device you are communicating with

Select Comport - Select the baud rate, parity, and bits of the comport connected to the device. The default setting of the DS1-PL and DS-16 is 4800,n,8,1 so most likely use this first unless you have programmed another baud rate into the DS1-PL. The DS-16 is always 4800,n,8,1 and can not be changed.

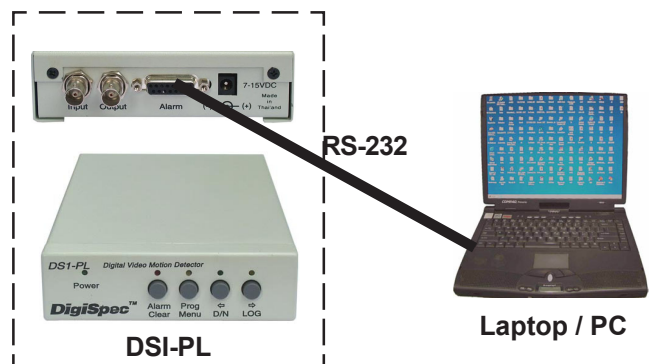

Figure 11: DS1-PL to Laptop Serial Connection

Ethernet Connection

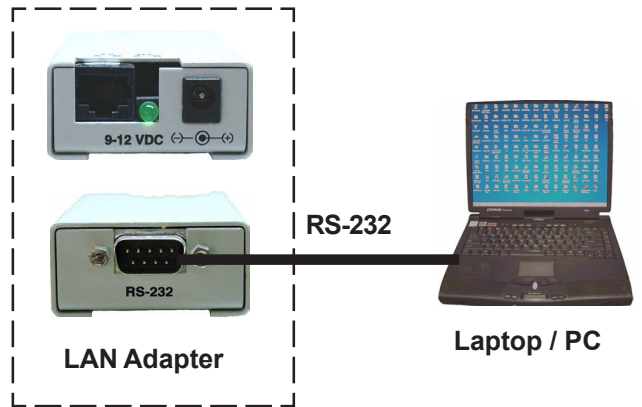

Figure 12: Setting IP/Baud Window

Setting;

Figure 13: LAN Adapter to Laptop Connection

IP Address - Set the preprogrammed IP address of the LAN adapter

Format NTSC or PAL - Select the proper format for cameras you are using

System DS1-PL or DS-16 - Select the device you are communicating with

BaudRate - Select the baud rate, parity, and bits of the connected device. The default setting of the DS1-PL and DS-16 is 4800,n,8,1 so most likely use this first unless you have programmed another baud rate into the DS1-PL. The DS-16 is always 4800,n,8,1 and can not be changed.

Setup IP Address

Figure 14: IP Address Setting Comport

Make sure the proper cable is connected from the PC to the LAN adapter. Select the Comport of the PC with baud rate, parity, and bits. The default baud rate of the LAN adapter is 4800,n,8,1 so select that first unless you have previously changed.

Figure 15: IP Address Setting

Type in the IP address you wish the LAN adapter to respond to. The display will show the present IP address programmed into the LAN adapter to show previous setting and to confirm new settings. Check you network IP addresses carefully and make sure you are not duplicating any other IP address on your network or a conflict will occur and cause problems.

Communication Complete

Upon successfully selecting one of the previous connection methods the following Main Menu will appear. If cabling or baud rate or other communications settings are not correct the error messages will be displayed and you will be returned to the previous menu selections to set correctly.

Figure 16: Main Menu

From this Main Menu you will be able to set all the programming features of the DS1-PL.

“File Tab” - From this tab you can then save them on your PC, or open a previously saved configuration.

“Communications Tab” - From this tab you will be able to open the additional following windows, Keyboard, Alarm, and Serial or Status windows, along with Upload settings to the DS1-PL and Download from the DS1-PL to the PC and select the Day or Night Programming menu.

“Help Tab” - From this tab you can open the online “DS1-PL” Manual for detailed description of each programming option.

For additional information on the DSVMD Software refer to the DSVMD Software Manual on the included CD-ROM.

SERIAL PROTOCOL REV 10

	DS-16	DS1-PL
Serial Configuration	4800 baud No parity 8 data bit 1 or 2 Stop bits	Programmable No Parity 8 data bit 1 or 2 Stop bits

CONTROL: Two types

- a) Button Press Control, for simulating front panel button controls.
- b) Serial Dump Control, for loading settings from a computer etc.

Serial command for DS1-PL / DS-16 Version 10

- <00H>-<7FH> : Unit address 0 –127
- <80H>-<8FH> : Unit address blank 0-15,16-31,32-47,48-63,64-79,80-95,96-111,112-127
- <91H> : Right Button
- <92H> : Left Button
- <94H> : Menu Button
- <98H> : Alarm Button
- <A0H> : Unaddress
- <A1H> : Day mode
- <A2H> : Night mode
- <A4H> : Enable Alarm
- <A5H> : Disable Alarm
- <A8H> : Clear alarm
- <B0H> : Done Program(Address Mode)
- <B3H> : Menu Mode(Address Mode)
- <B4H> : Down Button(Address Mode)
- <B5H> : Up Button(Address Mode)
- <B6H> : Left Button(Address Mode)
- <B7H> : Right Button(Address Mode)
- <BDH> : View Log(Address Mode)

Reboot System and Restore Factory Defaults

- | | |
|---|--|
| <ul style="list-style-type: none"> 1. Start (1 byte)
Transmitter: <E0H> 2. Select Address (2 bytes)
Transmitter: <D0H or High nibble (Address)>
 <D0H or Low nibble (Address)> | <ul style="list-style-type: none"> 3. Command(2 bytes)
Reboot system <DEH>,<D0H>
Restore factory default and Reboot system
 <DEH>,<DFH> 4. End command(1 byte)
Transmitter: <EFh> |
|---|--|
- Example: Address of DS1-PL = 04
Transmitter:<D0H>,<D4H>

Serial Download

- <C0H> : Start download command
- <CFH> : End download command
- <DXH> : Send data for download command
- Download Date time
- Download Timer(Address Mode)
- Download Registers(Address Mode)
- Download Title(Address Mode)
- Download Zones(Address Mode)

Download Registers

1. Start download (1 byte)

Transmitter: <C0H>

2. Select address (2 bytes)

Transmitter: <D0H OR High nibble(Address)>
<D0H OR Low nibble(Address)>

Ex Address of DS-1PL = 04

Transmitter: <D0H>,<D4H>

3. Length of data (2 bytes)

Transmitter: <D3H>,<DAH>

4. Command for Download Title (4 bytes)

Transmitter: <D0H>,<D2H>,<D0H>,<D0H>

5. Send all registers in this

sequence(116 bytes)

5.1 Mode(2 bytes)

OFF	<D0H>,<D0H>
MOTION 1 AREA	<D0H>,<D1H>
MOTION 2 AREAS	<D0H>,<D2H>
MOTION 3 AREAS	<D0H>,<D3H>
MOTION 4 AREAS	<D0H>,<D4H>
MOTION 5 AREAS	<D0H>,<D5H>
MOTION 6 AREAS	<D0H>,<D6H>
MOTION 7 AREAS	<D0H>,<D7H>
MOTION 8 AREAS	<D0H>,<D8H>
DIRECTION A>B	<D0H>,<D9H>
DIRECTION A>B G>H	<D0H>,<DAH>
MOTION LESS 1 AREA	<D0H>,<DBH>
MOTION LESS 8 AREAS	<D0H>,<DCH>
MUSEUM	<D0H>,<DDH>
PTZ COMPATIBLE	<D0H>,<DEH>

5.2 Buzzer(2 bytes)

OFF <D0H>,<D0H>
ON <D0H>,<D1H>

5.3 Relay output(2 bytes)

OFF	<D0H>,<D0H>
ALARM	<D0H>,<D1H>
PRETRIG	<D0H>,<D2H>
T1	<D0H>,<D3H>
T2	<D0H>,<D4H>
T3	<D0H>,<D5H>
D/N	<D0H>,<D6H>

5.4 External input(2 bytes)

OFF	<D0H>,<D0H>
ALM-AND	<D0H>,<D1H>
ALM-OR	<D0H>,<D2H>
ENA	<D0H>,<D3H>
DISA	<D0H>,<D4H>
D/N	<D0H>,<D5H>
CAPREF	<D0H>,<D6H>

5.5 Watchdog Timer(2 bytes)

OFF	<D0H>,<D0H>
ON	<D0H>,<D1H>

5.6 Entrance delay(2 bytes)

00	<D0H>,<D0H>
99	<D6H>,<D3H>

5.7 Exit delay(2 bytes)

00	<D0H>,<D0H>
99	<D6H>,<D3H>

5.8 Alarm Process(2 bytes)

Time	<D0H>,<D0H>
Retrigger	<D0H>,<D0H>

5.9 Alarm Output Time(2 bytes)

Man	<D0H>,<D0H>
01	<D0H>,<D1H>
99	<D6H>,<D3H>

5.10 Alarm reset time(2 bytes)

00	<D0H>,<D0H>
99	<D6H>,<D3H>

5.11 Display layout(2 bytes)

OFF	<D0H>,<D0H>
STACKED	<D0H>,<D1H>
SERIES	<D0H>,<D2H>

5.12 Horizontal position(2 bytes)

1	<D0H>,<D1H>
12	<D0H>,<DCH>

5.13 Vertical position(2 bytes)

1	<D0H>,<D1H>
NTSC 22	<D1H>,<D6H>
PAL 27	<D1H>,<DBH>

APPENDIX E

5.14 Status(2 bytes)

OFF	<D0H>,<D0H>
AREA A DELTA	<D0H>,<D1H>
AREA B DELTA	<D0H>,<D2H>
AREA C DELTA	<D0H>,<D3H>
AREA D DELTA	<D0H>,<D4H>
AREA E DELTA	<D0H>,<D5H>
AREA F DELTA	<D0H>,<D6H>
AREA G DELTA	<D0H>,<D7H>
AREA H DELTA	<D0H>,<D8H>
ALL DELTA	<D0H>,<D9H>
ALM FLAGS	<D0H>,<DAH>

5.15 Calendar(2 bytes)

OFF	<D0H>,<D0H>
MMM-DD-YY	<D0H>,<D1H>
YY-MMM-DD	<D0H>,<D2H>
DD-MMM-YY	<D0H>,<D3H>

5.16 Time display(2 bytes)

OFF	<D0H>,<D0H>
12 HOUR	<D0H>,<D1H>
24 HOUR	<D0H>,<D2H>

5.17 Trace Effect(2 bytes)

OFF	<D0H>,<D0H>
MOTION	<D0H>,<D1H>
MEMORY	<D0H>,<D2H>
MEMORY/F	<D0H>,<D3H>
MEMORY/S	<D0H>,<D4H>
MEMORY/A	<D0H>,<D5H>
MEMORY/AS	<D0H>,<D6H>

5.18 Video blackout(2 bytes)

OFF	<D0H>,<D0H>
ON	<D0H>,<D1H>
AUTO	<D0H>,<D2H>

5.19 Titler display(2 bytes)

OFF	<D0H>,<D0H>
ON	<D0H>,<D1H>

5.20 Serial port(2 bytes)

1200,n,8,1	<D0H>,<D0H>
2400,n,8,1	<D0H>,<D1H>
4800,n,8,1	<D0H>,<D2H>
9600,n,8,1	<D0H>,<D3H>
19200,n,8,1	<D0H>,<D4H>
28800,n,8,1	<D0H>,<D5H>

5.21 Address(2 bytes)

00	<D0H>,<D0H>
127	<D7H>,<DFH>

5.22 Output rate(2 bytes)

OFF	<D0H>,<D0H>
PER ALARM	<D0H>,<D1H>
CONTINUOUS	<D0H>,<D2H>

5.23 Output data(2 bytes)

MOVE FLAGS	<D0H>,<D0H>
TRIG FLAGS	<D0H>,<D1H>
ALARM FLAGS	<D0H>,<D2H>
STAT FLAGS	<D0H>,<D3H>
ALL FLAGS	<D0H>,<D4H>
AREA1 DELTA	<D0H>,<D5H>
AREA2 DELTA	<D0H>,<D6H>
AREA3 DELTA	<D0H>,<D7H>
AREA4 DELTA	<D0H>,<D8H>
AREA5 DELTA	<D0H>,<D9H>
AREA6 DELTA	<D0H>,<DAH>
AREA7 DELTA	<D0H>,<DBH>
AREA8 DELTA	<D0H>,<DCH>
TOTAL DELTA	<D0H>,<DDH>
EVENT LOG	<D0H>,<DEH>

5.24 Video loss alarm(2 bytes)

OFF	<D0H>,<D0H>
ON	<D0H>,<D1H>

5.25 Video loss buzzer(2 bytes)

OFF	<D0H>,<D0H>
ON	<D0H>,<D1H>

5.26 Video loss output(2 bytes)

RED SCREEN	<D0H>,<D0H>
VIDEO	<D0H>,<D1H>

5.27 Sensitivity(16 bytes)

00	<D0H>,<D0H>
99	<D6H>,<D3H>

Sensitivity Zone A 2 bytes
Sensitivity Zone B 2 bytes
Sensitivity Zone C 2 bytes
Sensitivity Zone D 2 bytes
Sensitivity Zone E 2 bytes
Sensitivity Zone F 2 bytes
Sensitivity Zone G 2 bytes
Sensitivity Zone H 2 bytes

5.28 Trigger level(32 bytes)

0 <D0H>,<D0H>,<D0H>,<D0H>
 65,535 <DFH>,<DFH>,<DFH>,<DFH>

Trigger Level Zone A 4 bytes
 Trigger Level Zone B 4 bytes
 Trigger Level Zone C 4 bytes
 Trigger Level Zone D 4 bytes
 Trigger Level Zone E 4 bytes
 Trigger Level Zone F 4 bytes
 Trigger Level Zone G 4 bytes
 Trigger Level Zone H 4 bytes

5.29 Tracking Time Setting (16 bytes)

0.0sec <D0H>,<D0H>
 0.1 sec <D0H>,<D1H>
 0.9 sec <D0H>,<D9H>
 1.0 sec <D0H>,<DAH>
 7.9 sec <D4H>,<DFH>
 8.0 sec <D5H>,<D0H>
 10 sec <D6H>,<D4H>
 11 sec <D6H>,<D5H>
 59 sec <D9H>,<D5H>
 1.00 minute <D9H>,<D6H>
 1.05 minute <D9H>,<D7H>
 1.10 minute <D9H>,<D8H>
 1.55 minute <DAH>,<D1H>
 2.00 minute <DAH>,<D2H>
 3.00 minute <DAH>,<DEH>
 4.00 minute <DBH>,<DAH>
 5.00 minute <DCH>,<D6H>

Tracking Zone A 2 bytes
 Tracking Zone B 2 bytes
 Tracking Zone C 2 bytes
 Tracking Zone D 2 bytes
 Tracking Zone E 2 bytes
 Tracking Zone F 2 bytes
 Tracking Zone G 2 bytes
 Tracking Zone H 2 bytes

6. End command(1 byte)

Transmitter: <CFh>

Download Zones

1. Start download (1 byte)

Transmitter: <C0H>

2. Select address (2 bytes)

Transmitter: <D0H OR High nibble(Address)>
 <D0H OR Low nibble (Address)>

Ex Address of Ds-1pl = 03

Transmitter: <D0H>,<D3H>

3. Length of data (2 bytes)

Transmitter: <D4H>,<D8H>

4. Command for download Zones(4 bytes)

*Row 1 Column – Row 6 Column 24
 Transmitter: <D0H>,<D4H>,<D0H>,<D0H>
 *Row 7 Column – Row 12 Column 24
 Transmitter: <D0H>,<D5H>,<D0H>,<D0H>

5. Send all registers in this

sequence(144 bytes)

Row 1 Column 1-24	1 - 24
Row 2 Column 1-24	25 - 48
Row 3 Column 1-24	49 - 72
Row 4 Column 1-24	73 - 96
Row 5 Column 1-24	97 - 120
Row 6 Column 1-24	121 - 144
Row 7 Column 1-24	1 - 24
Row 8 Column 1-24	25 - 48
Row 9 Column 1-24	49 - 72
Row 10 Column 1-24	73 - 96
Row 11 Column 1-24	97 - 120
Row 12 Column 1-24	121 - 144

A	<D0H>
B	<D1H>
C	<D2H>
D	<D3H>
E	<D4H>
F	<D5H>
G	<D6H>
H	<D7H>
OFF	<D8H>

6. End command(1 byte)

Transmitter: <CFh>

APPENDIX E

Download Date Time

1. Start download (1 byte)

Transmitter: <C0H>

2. Select all address (2 bytes)

Transmitter: <D8H>, <D0H>

3. Length of data (2 bytes)

Transmitter: <D0H>, <D9H>

4. Command for download date time(4 bytes)

Transmitter: <D0H>, <D0H>, <D0H>, <D0H>

5. Send all registers in this sequence(18 bytes)

5.1 Month

JAN	<D0H>, <D1H>
FEB	<D0H>, <D2H>
MAR	<D0H>, <D3H>
APR	<D0H>, <D4H>
MAY	<D0H>, <D5H>
JUN	<D0H>, <D6H>
JUL	<D0H>, <D7H>
AUG	<D0H>, <D8H>
SEP	<D0H>, <D9H>
OCT	<D1H>, <D0H>
NOV	<D1H>, <D1H>
DEC	<D1H>, <D2H>

5.2 Date

00	<D0H>, <D0H>
31	<D3H>, <D1H>

5.3 Year

00	<D0H>, <D0H>
99	<D9H>, <D9H>

5.4 Hours

00	<D0H>, <D0H>
23	<D2H>, <D3H>

5.5 Minutes

00	<D0H>, <D0H>
59	<D5H>, <D9H>

5.6 Second

00	<D0H>, <D0H>
59	<D5H>, <D9H>

5.7 Day of week

SUN	<D0H>, <D1H>
MON	<D0H>, <D2H>
TUE	<D0H>, <D3H>
WED	<D0H>, <D4H>
THU	<D0H>, <D5H>
FRI	<D0H>, <D6H>
SAT	<D0H>, <D7H>

5.8 Alarm Counter

00	<D0H>, <D0H>
99	<D6H>, <D3H>

5.9 Daylight Saving Time

OFF	<D0H>, <D0H>
USA	<D0H>, <D1H>
CANADA	<D0H>, <D2H>

6. End command(1 byte)

Transmitter: <CFh>

Download Timer

1. Start download (1 byte)

Transmitter: <C0H>

2. Select address (2 bytes)

Transmitter: <D0H OR High nibble(Address)>
<D0H OR Low nibble(Address)>

Example: Address of DS-1PL = 02

Transmitter: <D0H>, <D2H>

3. Length of data (2 bytes)

Transmitter: <D1H>, <D4H>

4. Command for download timer(4 bytes)

Transmitter: <D0H>, <D1H>, <D0H>, <D0H>

5. Send all registers in this sequence(40 bytes)

APPENDIX E

5.1 Timer1

OFF	<D0H>,<D0H>
SUN	<D0H>,<D1H>
MON	<D0H>,<D2H>
TUE	<D0H>,<D3H>
WED	<D0H>,<D4H>
THU	<D0H>,<D5H>
FRI	<D0H>,<D6H>
SAT	<D0H>,<D7H>
M-F	<D0H>,<D8H>
M-S	<D0H>,<D9H>
S-S	<D0H>,<DAH>
ALL	<D0H>,<DBH>

5.2 Timer1 hour start

00	<D0H>,<D0H>
23	<D2H>,<D3H>

5.3 Timer1 minute start

00	<D0H>,<D0H>
59	<D5H>,<D9H>

5.4 Timer1 hour stop

00	<D0H>,<D0H>
23	<D2H>,<D3H>

5.5 Timer1 minute stop

00	<D0H>,<D0H>
59	<D5H>,<D9H>

5.6 Timer2

OFF	<D0H>,<D0H>
SUN	<D0H>,<D1H>
MON	<D0H>,<D2H>
TUE	<D0H>,<D3H>
WED	<D0H>,<D4H>
THU	<D0H>,<D5H>
FRI	<D0H>,<D6H>
SAT	<D0H>,<D7H>
M-F	<D0H>,<D8H>
M-S	<D0H>,<D9H>
S-S	<D0H>,<DAH>
ALL	<D0H>,<DBH>

5.7 Timer2 hour start

00	<D0H>,<D0H>
23	<D2H>,<D3H>

5.8 Timer2 minute start

00	<D0H>,<D0H>
59	<D5H>,<D9H>

5.9 Timer2 hour stop

00	<D0H>,<D0H>
23	<D2H>,<D3H>

5.10 Timer1 minute stop

00	<D0H>,<D0H>
59	<D5H>,<D9H>

5.11 Timer 3

OFF	<D0H>,<D0H>
SUN	<D0H>,<D1H>
MON	<D0H>,<D2H>
TUE	<D0H>,<D3H>
WED	<D0H>,<D4H>
THU	<D0H>,<D5H>
FRI	<D0H>,<D6H>
SAT	<D0H>,<D7H>
M-F	<D0H>,<D8H>
M-S	<D0H>,<D9H>
S-S	<D0H>,<DAH>
ALL	<D0H>,<DBH>

5.12 Timer3 hour start

00	<D0H>,<D0H>
24	<D2H>,<D3H>

5.13 Timer3 minute start

00	<D0H>,<D0H>
59	<D5H>,<D9H>

5.14 Timer3 hour stop

00	<D0H>,<D0H>
23	<D2H>,<D3H>

5.15 Timer3 minute stop

00	<D0H>,<D0H>
59	<D5H>,<D9H>

5.16 Day/Night Timers

OFF	<D0H>,<D0H>
ON	<D0H>,<D1H>

5.17 Day hour start

00	<D0H>,<D0H>
23	<D2H>,<D3H>

5.18 Day minute start

00	<D0H>,<D0H>
59	<D5H>,<D9H>

APPENDIX E

5.19 Night hour start

00 <D0H>,<D0H>
23 <D2H>,<D3H>

5.20 Night minute start

00 <D0H>,<D0H>
59 <D5H>,<D9H>

6. End command(1 byte)

Transmitter: <CFh>

Download Title

1. Start download (1 byte)

Transmitter: <C0H>

2. Select address (2 bytes)

Transmitter: <D0H OR Highnibble(Address)>
<D0H OR Low nibble(Address)>

Example: Address of Ds-1pl = 01

Transmitter: <D0H>,<D1H>

3. Length of data (2 bytes)

Transmitter: <D1H>,<D1H>

4. Command for DownloadTitle (4 bytes)

Transmitter: <D0H>,<D3H>,<D0H>,<D0H>

5. Title 32 Bytes for 16 characters

'0'	=	<D0H>,<D0H>
'1'	=	<D0H>,<D1H>
'2'	=	<D0H>,<D2H>
'3'	=	<D0H>,<D3H>
'4'	=	<D0H>,<D4H>
'5'	=	<D0H>,<D5H>
'6'	=	<D0H>,<D6H>
'7'	=	<D0H>,<D7H>
'8'	=	<D0H>,<D8H>
'9'	=	<D0H>,<D9H>
','	=	<D0H>,<DAH>
'<'	=	<D0H>,<DBH>
'>'	=	<D0H>,<DCH>
'<'	=	<D0H>,<DDH>
'>'	=	<D0H>,<DEH>
'<'	=	<D0H>,<DFH>
'>'	=	<D0H>,<DFH>
Space	=	<D1H>,<D0H>
'A'	=	<D1H>,<D1H>

'B'	=	<D1H>,<D2H>
'C'	=	<D1H>,<D3H>
'D'	=	<D1H>,<D4H>
'E'	=	<D1H>,<D5H>
'F'	=	<D1H>,<D6H>
'G'	=	<D1H>,<D7H>
'H'	=	<D1H>,<D8H>
'I'	=	<D1H>,<D9H>
'J'	=	<D1H>,<DAH>
'K'	=	<D1H>,<DBH>
'L'	=	<D1H>,<DCH>
'M'	=	<D1H>,<DDH>
'N'	=	<D1H>,<DEH>
'O'	=	<D0H>,<D0H>
'P'	=	<D2H>,<D0H>
'Q'	=	<D2H>,<D1H>
'R'	=	<D2H>,<D2H>
'S'	=	<D2H>,<D3H>
'T'	=	<D2H>,<D4H>
'U'	=	<D2H>,<D5H>
'V'	=	<D2H>,<D6H>
'W'	=	<D2H>,<D7H>
'X'	=	<D2H>,<D8H>
'Y'	=	<D2H>,<D9H>
'Z'	=	<D2H>,<DAH>

6. Relay State (2 bytes)

NO <D0H>,<D0H>
NC <D0H>,<D1H>

7. End command(1 byte)

Transmitter: <CFh>

APPENDIX F PC to DS1-PL Connection Pin-Out

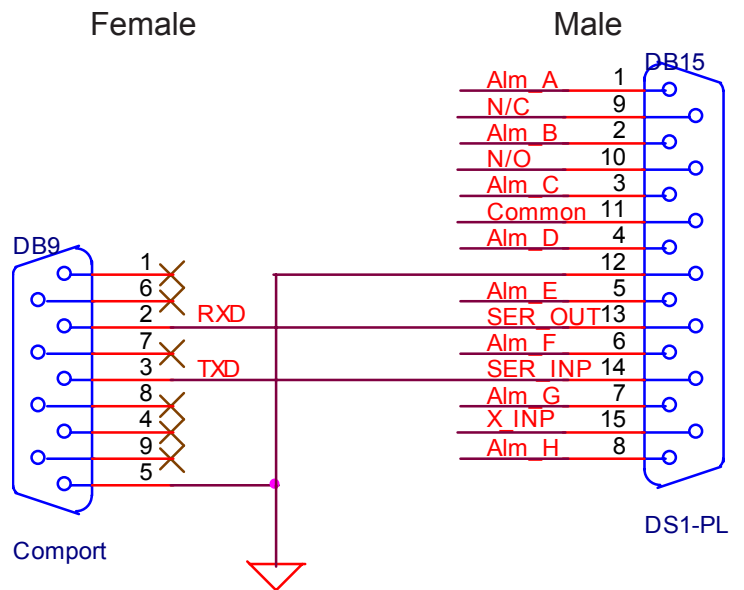

Figure 8 : PC to DS1-PL Connection Pin-Out

WARRANTY

Limited Warranty (Terms and Conditions)

LIMITED WARRANTY

For **2 Years** from the date of shipment, Seller warrants to Buyer that the Product is free from defects in material or workmanship **UNDER NORMAL USE AND SERVICE**. Equipment manufactured or supplied by others (manufacturers other than Seller) but furnished by Seller carries the same warranty to Buyer as Seller receives from the other manufacturer, NOTWITHSTANDING ANY PROVISION TO THE CONTRARY, if Buyer has specified a particular manufacturer's product which is not the brand standardly supplied by Seller, Buyer shall look only to the other manufacturer's warranty and Seller shall not warrant such item. In such event, Buyer shall obtain only the warranty which comes with such other manufacturer's product.

EXCLUSIONS. Seller's warranty does not cover the following:

- (1) in transit damage claims, improper handling by carrier or post office (NOTE: only the consignee of the shipment can file a claim with the common Carrier);
- (2) damages caused by incorrect use, modification, carelessness, unauthorized alterations, improper storage or unauthorized service, installation or repairs;
- (3) damages caused by fire, flood, lightning, collision, acts of God or other events beyond the control of Seller;
- (4) products or parts thereof that have had serial numbers removed, altered or defaced;
- (5) products received for repair without a RMA number and a sales or delivery receipt showing the date of original purchase;
- (6) hostile operating conditions;
- (7) use of components that do not meet Seller's specifications;
- (8) damage or failure caused by or resulting from the operation of the product with incorrect voltage;
- (9) external parts such as cabinets or keypads;
- (10) periodic maintenance and adjustments resulting from normal use.
- (11) installation or repair of the equipment without proper training from the Seller

WARRANTIES EXCLUDED

SELLER EXPRESSLY DISCLAIMS AND EXCLUDES ANY EXPRESS OR IMPLIED WARRANTY OR MERCHANTABILITY OR FITNESS FOR A PARTICULAR PURPOSE WHICH EXCEEDS OR IS INCONSISTENT WITH THE WARRANTY HEREIN EXPRESSLY SET FORTH.

NON-WARRANTY CLAIMS

In the event Buyer makes a warranty claim and Seller's warranty does not apply, Buyer shall reimburse Seller for all reasonable expenses incurred by Seller in diagnosing the Installation/repair problem. Seller shall not be responsible for any damages to the Product or other property due to installation or service by a party not authorized by Seller.

BUYER'S EXCLUSIVE REMEDIES

If the Product supplied shall fail to conform to the contract or any applicable warranty, Buyer shall immediately notify Seller of such condition and afford Seller a reasonable opportunity to inspect said Product. Seller shall, at its option, either repair or replace such nonconforming Product. Seller shall not be responsible for labor charges for removal or installation of such equipment or material or charges for transportation, handling and shipping except as provided in Seller's written service policy. No Product shall be returned without Seller's prior written consent.

SELLER SHALL NOT BE LIABLE FOR ANY SPECIAL, DIRECT INCIDENTAL OR CONSEQUENTIAL DAMAGES OF A COMMERCIAL NATURE ARISING OUT THE USE OF OR INABILITY TO USE SELLER'S PRODUCT BY REASON OF THE FACT THAT SUCH PRODUCT DOES NOT CONFORM TO THE CONTRACT OR TO ANY EXPRESS OR IMPLIED WARRANTY. SELLER'S MAXIMUM LIABILITY SHALL BE LIMITED TO THE COST OF REPAIR AND/OR REPLACEMENT OF THE PRODUCT CLAIMED TO BE DEFECTIVE OR NONCONFORMING, SUBJECT TO SELLER'S RIGHT OF REMOVAL AND RETURN OF PRODUCT.

DigiSpecTM

DigiSpec Inc.

1906 Treble Dr.
Humble, Texas 77338
Tel: 702-341-6799 Fax: 702-341-0334
Email: john@digispecvideomotion.com
Web Site: www.digispecvideomotion.com

Las Vegas Sales Office

9070 Royal Monarch Ct.
Las Vegas, Nevada 89147
Tel: 702-341-6799 Fax: 702-341-0334