

INSTALLATION & OPERATION MANUAL

Digital Video Recorder

MV-DR3000

AVE

MULTI*view*

Before trying to connect or operate this product, please read this manual completely

SAFETY PRECAUTIONS









All the following safety and operated instructions which will prevent harm or damage to the operator and other persons should be read before the unit is operated.

INFORMATION



This equipment has been tested and found to comply with the limits for a Class A digital device, pursuant to Part 15 of the FCC Rules. These limits are designed to provide reasonable protection against harmful interference when the equipment is operated in a commercial environment. This equipment generates, uses, and can radiate radio frequency energy and, if not installed and used in accordance with the instruction manual, may cause harmful interference with radio communications.

Operation of this equipment in a residential area is likely to cause harmful interference in which case the user will be required to correct the interference at his own expense.

WARNING

-  To reduce the risk of fire or electric shock, do not expose this appliance to rain or moisture.
-  Do not block ventilation openings.
-  Do not place anything on top of the unit that might spill or fall into it.
-  Do not attempt to service this unit yourself as opening or removing covers may expose you to dangerous voltage or other hazards. Please refer all servicing to qualified service personnel.
-  Do not use liquid cleaners or aerosols for cleaning.
-  This installation should be by a qualified service person and should conform to all local codes.
-  To prevent fire or electric shock, do not overload wall outlets or extension cords.
-  This unit must be grounded to reduce the risk of electric shock hazard.

CAUTION

-  Danger of explosion if battery(RTC Battery) is incorrectly replaced. Replace only with the same or equivalent type recommended by the manufacturer. Dispose of used batteries according to the manufacturer's instructions.
-  Risk of explosion if replaced by an incorrect type. Dispose of used batteries according to the instructions.

CONTENTS

| | | | |
|---|-----------|--|--|
| 1. INTRODUCTION | 4 | | |
| 1.1 Product Introduction | 4 | | |
| 1.2 Product Features | 4 | | |
| 1.3. FRONT / REAR VIEW..... | 5 | | |
| 1.3.1 Front View | 5 | | |
| 1.3.2 Rear View..... | 8 | | |
| 1.4 ALARM In / Out | 9 | | |
| 2. INSTALLATION | 10 | | |
| 2.1 Basic Connection | 10 | | |
| 2.2 Hard-disk Drive Installation | 11 | | |
| 2.3 System Information | 12 | | |
| 2.4 Updating System Software..... | 13 | | |
| 3. OPERATIONS | 14 | | |
| 3.1 Configuring Recording Settings | 14 | | |
| 3.2 Recording Operations | 17 | | |
| 3.2.1 Manual Recording..... | 17 | | |
| 3.2.2 Timer Recording..... | 17 | | |
| 3.2.3 Alarm / Motion Recording..... | 18 | | |
| 3.2.4 Externally Triggered Recording | 18 | | |
| 3.3 Playback Operations | 20 | | |
| 3.3.1 Normal Playback..... | 20 | | |
| 3.3.2 Fast Forward/Backward | 20 | | |
| 3.3.3 Slow Forward/Reverse..... | 21 | | |
| 3.3.4 Play back Picture-by-picture | 21 | | |
| 3.3.5 Playback Recorded Video from an HDD of the mobile rack (for removable HDD model only) | 21 | | |
| 3.3.6 Picture in Picture (PinP) Display Mode | 21 | | |
| 3.4 Search Operations | 22 | | |
| 3.4.1 FULL LIST Search | 22 | | |
| 3.4.2 ALARM LIST Search..... | 22 | | |
| 3.4.3 TIME Search | 23 | | |
| 3.4.4 THUMBNAIL Search | 23 | | |
| 3.4.5 SD CARD Search | 24 | | |
| 3.4.6 CD Menu (For CD-RW model only) | 25 | | |
| 3.5 Backup Operations | 26 | | |
| 3.5.1 CD Rewritable unit Backup Operations (FOR CD-ROM MODEL ONLY)..... | 26 | | |
| 3.5.2 Mobile Rack HD Backup Operations (FOR REMOVABLE HDD MODEL ONLY) | 27 | | |
| 3.5.3 SD Card Backup Operations for Removable HDD Model | 28 | | |
| 3.5.4 Backup the System setting info into an SD card. | 29 | | |
| 3.5.5 Updating System Software..... | 30 | | |
| 3.6 Key Lock Operation..... | 30 | | |
| 4. MENU SETUP | 31 | | |
| 4.1 REC Setting | 31 | | |
| 4.2 ALARM / MOTION Setting | 32 | | |
| 4.3 CLOCK / TIMER Setting | 34 | | |
| 4.4 COMMUNICATION Setting | 35 | | |
| 4.5 DISK Setting..... | 37 | | |
| 4.6 SYSTEM Setting | 39 | | |
| 5. NETWORK..... | 41 | | |
| 5.1 Network Configuration..... | 41 | | |
| 5.1.1 Cable Connections..... | 41 | | |
| 5.1.2 Configure Your DVR Network Settings | 42 | | |
| 5.1.3 TCP/IP Communication Setup | 44 | | |
| 5.1.4 Testing Connection..... | 46 | | |
| 5.2 TRIPLEX 1 CH DVR VIEWER SOFTWARE: Introduction | 47 | | |
| 5.2.1 Software installation..... | 47 | | |
| 5.2.2 Short introduction | 48 | | |
| 5.2.3 Operation..... | 49 | | |
| 5.3 Microsoft Internet Explorer | 55 | | |
| 5.3.1 Connecting the DVR | 55 | | |
| 5.3.2 Change Record / Alarm Setting | 56 | | |
| 5.3.3 Change Timer Record Setting..... | 56 | | |
| 5.3.4 Pan / Tilt / Zoom Setting..... | 57 | | |
| 6. TEXT INSERTION FUNCTION | 58 | | |
| 7. MISCELLANEOUS | 73 | | |
| 7.1 RS-232 & RS-485 Setup & Protocol | 73 | | |
| 7.1.1 RS232 & RS485 Setup | 73 | | |
| 7.1.2 Communication Protocol..... | 73 | | |
| 7.2 Hard Disk Installation | 77 | | |
| 7.2.1 Built-in hard disk..... | 77 | | |

| | |
|--|-----------|
| 7.2.2 Mobile Rack (FOR REMOVABLE HDD MODEL)..... | 78 |
| 7.3 System Default..... | 80 |
| 7.4 O.S.D Message..... | 81 |
| 7.5 Time Index Table..... | 82 |
| 7.6 Specifications..... | 83 |
| 7.7 Compatible Multiplexer Devices..... | 84 |
| 7.8 ScanIP..... | 85 |
| APPENDIX 1. – Using CD Discs | |
| (FOR CD-RW MODEL ONLY) | 87 |

1. INTRODUCTION

1. INTRODUCTION

1.1 Product Introduction

This 1CH Triplex DVR is a storage media of digital video image, which uses hard disk drives instead of VCR tapes to store video. It enables you to enjoy the extreme flexibility of digital image archiving instead of clumsy tape management, and is compatible with most multiplexers in the market. Equipped with a range of comprehensive features, such as playback picture-by-picture, fast accessed video recording by time and event, system software which can be upgraded, the expandable capacities of hard drive, and much more, the DVR will make your applications far more flexible and effective than ever before. For all, the DVR is going to prove the timely substitute for Time-lapse VCR.

1.2 Product Features

- The full-capability triplex DVR allows video recording while viewing live video images and video playback images at the same time.
- Stores video in hard-disk drives instead of VCR tapes.
- Main recording media: one fixed hard-disk drive and one removable hard-disk (for removable model only).
- Main recording media: one fixed HDD plus a CD-RW. (For CD-ROM model only)
- Hard-disk drive hot-swapping capability.
- Pre-alarm image recording.
- Capable of working with various known multiplexers.
- Time-lapse and real-time recording.
- Refresh rate up to 60 IPS (50 IPS for PAL).
- Image quality selectable at 4 different levels for recording.
- Event/Timer/Alarm recording mode.
- Quick search by time, alarm, event, and recording list.
- Fast and slow playback of recorded video at various speeds.
- Single-picture playback.
- On-screen setup menu, title and system timer.
- Password protection.
- Motion detection.
- Disk-full warning and operation status LEDs.
- RS-232, RS-485 communication ports.
- Remote control via RS-232, RS-485 and Ethernet ports.
- Power recovery on interruption.
- Operation-status record log.
- Distributes live and recorded images through the TCP/IP network environment.
- Audio function included (16 bits, 11 KHz / 22KHz).
- Built-in SD card slot for copying image to SD card.
- Supports DHCP protocol.

INTRODUCTION (continued)

1.3. FRONT / REAR VIEW

1.3.1 Front View

FOR CD-ROM MODEL

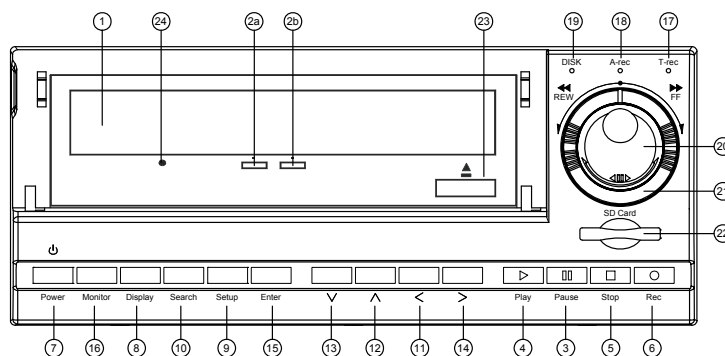

FOR REMOVABLE HDD MODEL

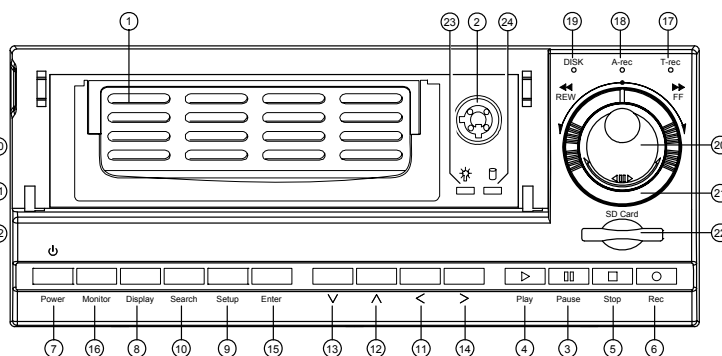

① **CD-RW device compartment:**

The compartment allows you to burn the data mostly for backup purposes. This tray is for loading the CD disc. It will accept 120 mm and 80 mm discs. Please place the discs in the exact center of the tray.

②a **Writing Display Light:**

When a disc is being burnt, the display light will be a red flash.

②b **Power Supply / Reading Light:**

When a disc has been ejected, the display light will be green. When a disc is unable to be read, or the device is being repaired, the display light will flash.

① **Hard-disk drive compartment:**

The compartment allows you to install a hard disk drive mostly for backup purposes. Make sure the drive is well secured with the mounting screws in the mobile rack before you put the rack into the compartment. And remember to turn on the power of the compartment by locking it.

② **Hard-disk compartment lock:**

The key lock secures a hard disk in place. Unlock the compartment before you remove the hard disk from the slot without turning off the device.

- ③ **PAUSE** button:
In a playback display, press this to freeze the display. During the freeze, press to display one frame/field of a picture at a time in the forward direction. (A green light is on the PAUSE mode.)
- ④ **PLAY** button:
Press to play back a recorded video from the hard disk. (A green light shows in the PLAY mode.)
- ⑤ **STOP** button:
Press to stop playing back a recorded video. (A green light goes on in the STOP mode.)
- ⑥ **REC** button:
Push to start recording video into a hard disk while in the live display mode. (A red light turns on in the REC mode.)
- ⑦ **POWER** button:
Press this button for at least 3 seconds to power off. Press again to activate the device.
- ⑧ **DISPLAY** button:
Press to show the system operation status on the screen.
- ⑨ **Setup** button:
Press this to enter the setup menu. Press again to exit the setup mode.
- ⑩ **Search** button:
Press to enter the search mode to access the recorded video.
- ⑪⑭ **Left / Right** buttons:
Press the two buttons to highlight desired items in the menu setup mode. For the **Key Lock** operation, press these two buttons simultaneously once; to disable **Key Lock**, press these two buttons again simultaneously.
- ⑫⑬ **Up / Down** buttons:
Press these two buttons to select the desired contents for programming in the setup menu mode.
- ⑮ **Enter** Button:
Press to enter a selected item and save the setting in the menu setup mode.
- ⑯ **Monitor** button:
Press to switch between a multiplexer-decoded video and the encoded video to be displayed when connected with a multiplexer. When the button light is on it indicates the unit is displaying the decoded video.(The images are not multiplexing .) In this mode, the unit doesn't display the OSD message of the unit on the screen. However, this doesn't affect the unit's OSD message, which is recorded into hard-disk drives. When the button light is off it indicates the unit is displaying encoded video. (The images switch swiftly).
- ⑰ **T-rec Indicator**:
This indicator of the timer recording mode lights up to signal the scheduled record setting is on.
- ⑱ **A-rec Indicator**:
This indicator of the alarm-recording mode lights up to indicate the alarm record setting is on.
- ⑲ **DISK Indicator**:
The indicator shows the operation status of the unit's hard-disk drives. The green light indicates the hard-disk drive is storing or retrieving data. The red light signals the hard-disk drive is filling up.

The orange light indicates the hard-disk is retrieving a disk-full status.

⑳ **Shuttle Ring:**

The shuttle can be moved forward and backward for playback in either direction. Turn this left to play a recorded video in the reverse direction at faster or slower speeds than the recorded speed. Turn this right to play a recorded video in the forward direction at faster or slower speeds than the recorded speed.

㉑ **Jog Dial:**

This dial can act in both a forward and a backward direction, as well as step by step. Turn this left to play a recorded video in the reverse direction. Turn this right to play a recorded video in the forward direction.

㉒ **SD CARD Slot:**

This is used for system software updating and archiving/accessing critical images.

㉓ **Eject button**

Pressing this controls the insertion and ejection of the tray.

㉔ **Emergency Eject Button:**

When the power supply has been interrupted, or it is impossible to eject a disc, please use a pin to press the emergency eject button so that the caddy will eject the disc.

㉓ **Mobile Rack Power LED:**

Indicates the power status of the Mobile Rack. The green light indicates the Mobile Rack is activating.

㉔ **Mobile Rack HDD LED:**

Indicates the HDD status of the Mobile Rack. The orange light indicates the HDD is storing or retrieving data.

1.3.2 Rear View

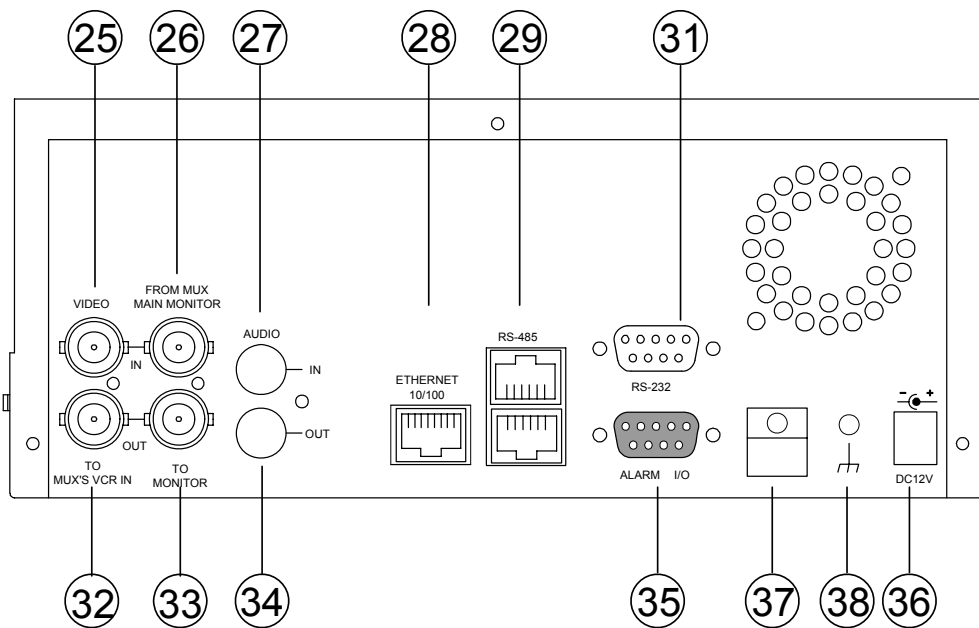

- 25 VIDEO IN Connector:** This BNC connector is used to connect the video output from a camera or a MUX to the DVR.
- 26 FROM MUX MAIN MONITOR Connector:** This BNC connector is used to connect the live video output from a MUX to the DVR.
- 27 AUDIO IN Connector:** This connector is used to connect the audio output from a camera, a MUX or other devices to the DVR.
- 28 ETHERNET 10/100 Connector:** This is a standard RJ-45 connector for 10/100 Mbps Ethernet networks.
- 29 RS-485 Port:** The RS-485 communication ports function as connectors when two or more units are serially connected to an external control device.
- 31 RS-232 Port:** The RS-232 communication port functions as a connector to an external control device. Please refer to **6.1 RS-232 & RS-485 Protocol** for more details.
- 32 VIDEO OUT Connector:** The connector provides the unit's composite video signals to a MUX.
- 33 MONITOR Connector:** The connector provides the unit's composite video or a MUX's live signal if connected to a display device.
- 34 AUDIO OUT:** This provides the unit's audio signal to a speaker.
- 35 ALARM I/O:** This is a 9-PIN D-SUB connector including **SWITCH OUT, GROUND, ALARM OUT, DISK FULL, RECORD IN, ALARM RESET,** and **ALARM IN** points for connecting with external devices. Please refer to the next section for details.
- 36 Plug Inlet:** The inlet connects to an external power supply. Connect the 12 V DC UL-listed Class 2 Power Supply.
- 37 Wire Catch:** The wire catch secures the power cord and keeps it in place (so that it does not droop or hang loosely).
- 38 Ground Screw's:** The ground screw is for a chassis terminal.

1.4 ALARM In / Out

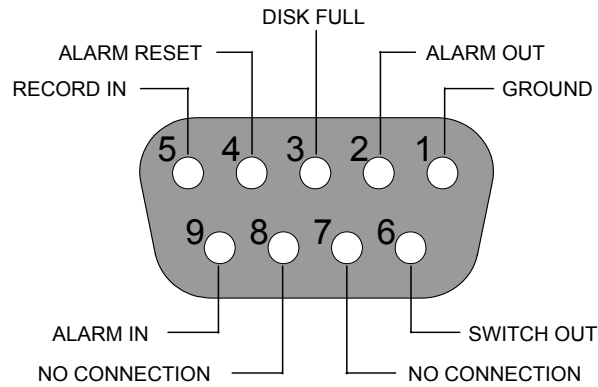

The above figure is a rear view.

1. **GND:** Ground Contact.
2. **ALARM OUT (OUTPUT):** This is an alarm-output trigger. Connect this to external devices such as buzzers or lights.

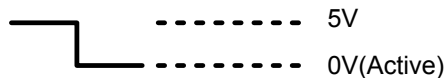

3. **DISK FULL (OUTPUT):** This is a disk-full output trigger. Connect this to external devices such as buzzers or lights.



4. **ALARM RESET (INPUT):** This pin connects to an alarm-clear device for clearing an alarm.



5. **RECORD IN (INPUT):** This pin connects to a record-triggering device for starting a record.



6. **SWITCH OUT (OUTPUT):** This pin, sending out timing signals (falling / negative) to a multiplexer, connects to a multiplexer's trigger terminal so the multiplexer can switch to using the same

recording speed as the DVR.

7. **NO CONNECTION**
8. **NO CONNECTION**
9. **ALARM IN (INPUT):** This is an alarm input, which can be programmed in the menu system to Normally Open or Normally Closed.



2. INSTALLATION

2. INSTALLATION

2.1 Basic Connection

A. Connecting with a Single Camera

Please set the **MULTIPLEXER** option to **OFF** on the **REC SETTING** page in the setup menu when it is connected with a single camera. (Please refer to section 4.1 MULTIPLEXER.)

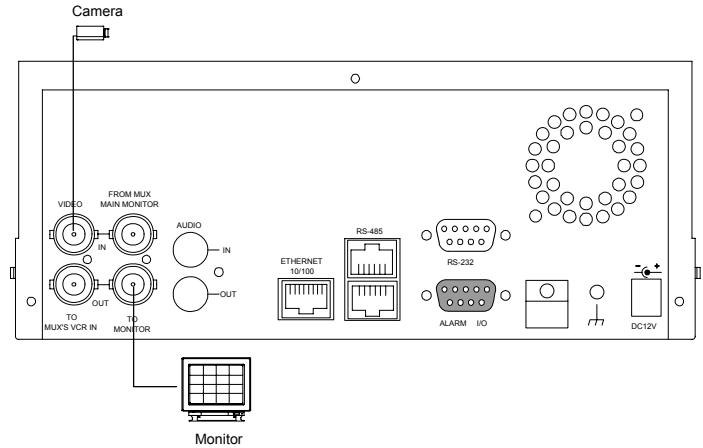

B. Connecting with a Multiplexer

To match the multiplexer's recording speed, please set the **MULTIPLEXER** option to **ON** on the **REC SETTING** page in the setup menu when it is connected with a multiplexer. (Please refer to section 4.1 MULTIPLEXER.)

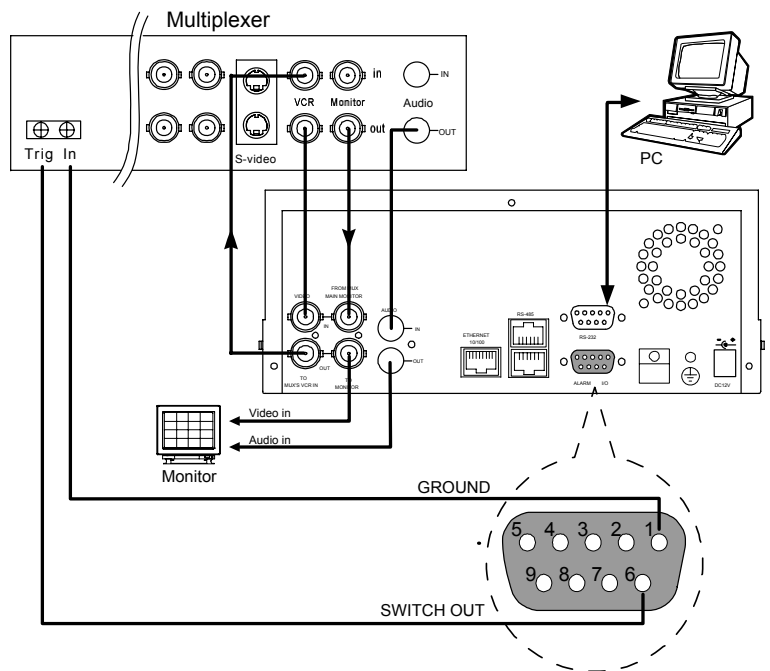

C. Connecting with a Quad

Please set the **MULTIPLEXER** option to **OFF** on the **REC SETTING** page in the setup menu when it is connected with a quad. (Please refer to section 4.1 MULTIPLEXER.)

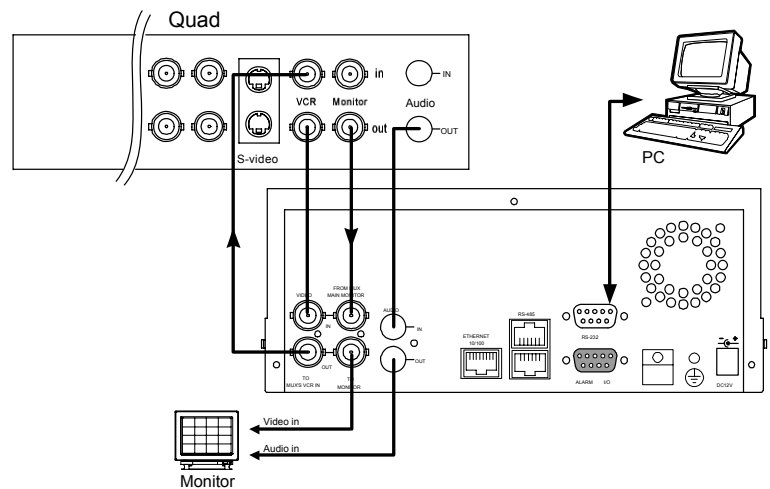

INSTALLATION (continued)

D. Attaching an External Device to DVR

Connect an alarm out, alarm input, and a peripheral device as shown in the diagram below.

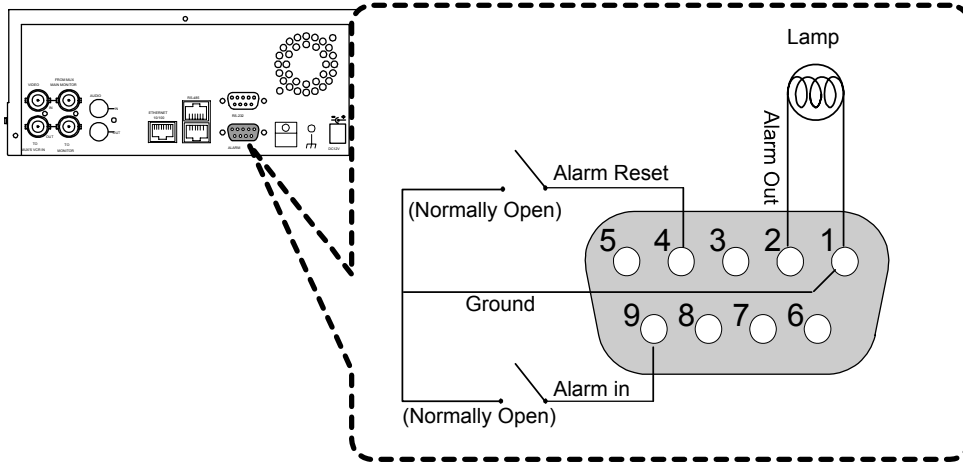

2.2 Hard-disk Drive Installation

The DVR is equipped with two compartments of hard disk drive (**for removable model only**). The unit usually comes with one hard-disk drive installed in the compartment HD1, which is default- configured as a master. If you need a second hard-disk drive to be installed in the compartment HD2 (Mobile), please contact your distributors or installers for specific instructions on how to install it. Please don't serve yourself before consulting your installers. If there is only one hard-disk drive in the mobile compartment, please set

the **HD2 USAGE** option to **REC** (please refer to section 4.5) before proceeding with the recording function. The jumper-settings arrangement of installed hard-disk drives for the system (Table 3.2 A.) is shown in the tables below.

Note: The **CD-RW model** is equipped with a fixed hard- disk and a CD-RW drive. The unit usually comes with one hard-disk drive installed in the compartment HD1, which is default-configured as a master.

Table 3.2 A. The jumper settings of hard-disk drives in the system

| | Location | Jumper |
|-------|------------------|------------------|
| IDE 1 | Compartment HD 1 | Master (Default) |
| IDE 2 | Compartment HD 2 | Master |

Table 3.2 B. Compatible hard-disk drives

| Manufacturer | Model | Capacity | Rotation |
|-----------------|----------------|----------|----------|
| Seagate | ST340810A | 40G | 5400 RPM |
| | ST380020A | 80G | 5400 RPM |
| | ST320014A | 20G | 5400 RPM |
| | ST340015A | 40G | 5400 RPM |
| | ST380012ACE | 80G | 5400 RPM |
| | ST3120025ACE | 120G | 5400 RPM |
| | ST340014A | 40G | 7200 RPM |
| | ST380011A | 80G | 7200 RPM |
| | ST380013A | 80G | 7200 RPM |
| | ST3120026A | 120G | 7200 RPM |
| | ST3160023A | 160G | 7200 RPM |
| | ST3200822A | 200G | 7200 RPM |
| | ST3250823A | 250G | 7200 RPM |
| | ST3400832A | 400G | 7200 RPM |
| Maxtor | 4A160J0-1A | 160G | 5400 RPM |
| | 4R080L0-1 | 80G | 5400 RPM |
| | 5A300J0-1A | 300G | 5400 RPM |
| | 6Y080L0 | 80G | 7200 RPM |
| | 6Y080L0-3 | 80G | 7200 RPM |
| | 6Y120L0-1 | 120G | 7200 RPM |
| | 6Y200P0-1A | 200G | 7200 RPM |
| | 6Y250P0-1A | 250G | 7200 RPM |
| | 6B300R0 | 300G | 7200 RPM |
| | 6L080P0 (RoHS) | 80G | 7200 RPM |
| | 6L100P0 (RoHS) | 100G | 7200 RPM |
| | 6L120P0 (RoHS) | 120G | 7200 RPM |
| | 6L160P0 (RoHS) | 160G | 7200 RPM |
| | 6L200P0 (RoHS) | 200G | 7200 RPM |
| | 6L250R0 (RoHS) | 250G | 7200 RPM |
| | 6L300R0 (RoHS) | 300G | 7200 RPM |
| Western Digital | WD800AB | 80G | 5400 RPM |
| | WD1200AB | 120G | 5400 RPM |
| | WD800BB | 80G | 7200 RPM |
| | WD1200BB | 120G | 7200 RPM |
| | WD1800BB | 180G | 7200 RPM |
| | WD2000BB | 200G | 7200 RPM |
| | WD2500JB | 250G | 7200 RPM |
| Samsung | SV0802N | 80G | 5400 RPM |
| | SV1203N | 120G | 5400 RPM |

NOTE: Hard-disk drives not shown on this list have not been tested by our engineering team and are not recommended for use with this product. For the latest updated list on the recommended hard disk drives, please contact your dealers or distributors.

2.3 System Information

You can display system settings information as shown on **Table 3.3 A** below at any time by pressing the **Display** button ^⑧. In the playback mode, the recorded video information is displayed. In the live or recording mode, the Manual Recording information is displayed. However, when the DVR is displaying a decoded image from a multiplexer, you must first switch the unit to encoded image displaying (the pictures is switching swiftly and the light of the **Monitor** button ^⑯ is off) by pressing the **Monitor** button ^⑯. Each

sequential press of the **Display** button ^⑧ displays a different message detailed in the following example. By default, the unit displays the time, date, and an indicating bar of capacity status on a monitor as shown.

Default Display



(Capacity Used) (Capacity Remaining)



09- 05-2003 16:13:02

(Date)

(Time)

Press the **Display** button  once; the DVR will display the following sample message plus the default display. Press the **Display** button  again; the unit will not display any OSD message. Press the button one more time to go back to the default display.

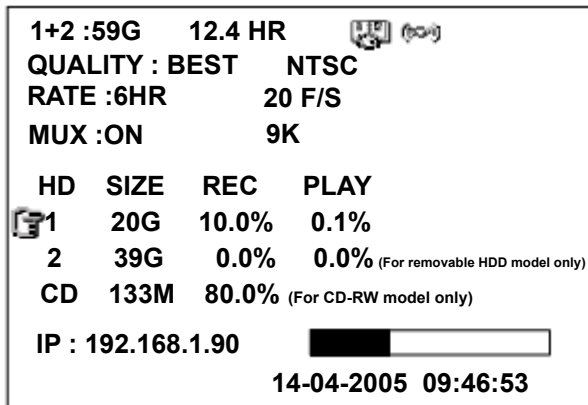

Total capacity of installed hard disk: 59 GB.

(12.4 HR): Total 12.4 hour recording time available.

(): Timer record activated.

(): Alarm record activated.

(): motion detection activated.

(QUALITY: BEST): Record quality setting: BEST.

(NTSC): NTSC system.

(RATE: 6 HR): Setting of Record time mode: 6 hours.

(20 F/S): Record speed setting: 20 fields/sec.

(MUX: OFF): Only connected to a single camera.

(): Audio function activated.

(): Indicates which HDD is activated.

(9K): The image file size.

(HD): Hard-disk compartment.(HD2 IS FOR REMOVABLE MODEL ONLY)

(CD):CD-RW Compartment. (FOR CD-RW MODEL ONLY)

(SIZE 20G): The capacity of the installed hard disk.

(REC): Percentage of system Recording.

(PLAY): Percentage of system Playback.

(IP : 192 . 168 . 1 . 90): Network IP Address
192.168.1.90



(): External signal.

( X): Cannot operate now.

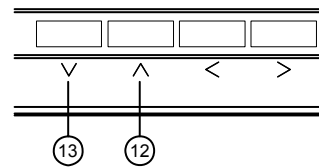
2.4 Updating System Software



Please take the following steps to safely update it.

1. Inserting your SD card into your SD card reader.
2. Plug your card reader's USB connector into your PC.
3. Save the firmware (the **multi.bin** file) into the SD card.
4. After you have checked that the saving is complete, take the SD card out of the card reader.
5. Turn off the DVR.
6. Insert the SD card into the built-in SD slot of the unit.
7. Hold down the the **Up**  and **Down**  buttons simultaneously, and then turn on the DVR.
8. Keep holding down the buttons until the DVR sounds a tone and display the message “XXXXXX BYTES READ” Now the DVR is updating the system software, which will take approximately 90 seconds to process.
9. Restart the unit when the device sounds a tone twice and displays the message “PLEASE RESTART” The process is complete.
(If you have already followed the procedure 1~9. the unit, however, not being able to power on. Please first check if the SD card you are using is functioning and the file is intact. And then start procedures 1 ~ 9 all over again.)
10. Verify the version of the system software from the “MAIN MENU -> SYSTEM -> VERSION” by push down Setup button. (Please refer to section 4.6 VERSION.)

Caution:

1. Before carrying out the updating procedures, please ensure the SD card is working and the file of system software is intact.
2. Don't interrupt the process while the unit is updating itself, as this will cause the unit to crash.

3. OPERATIONS

3. OPERATIONS

This section shows you how to operate and manage the DVR when it gets in the way.

3.1 Configuring Recording Settings

Recording time will vary depending on the image size, recording rate, and the capacity of the hard-disk drives. Generally, the DVR comes with a built-in hard-disk drive for continuous recording from one to four weeks under most recording conditions. The table below shows the possible recording times based on a 20GB hard-disk drive at certain refresh rates and the corresponding image quality. With one or more hard-disk drives in operation, please calculate the recording time using the table below in accordance with your requirement. For an NTSC unit, for example, if the unit is set to record images with **BEST** quality at a **60 fps** record rate, normally a 20GB hard-disk drive will be filled in 3.7 hours (see the gray area in the table). If the total capacity of 80GB hard-disk drives is in use under the same refresh rate and picture quality, it will be filled in 14.8 hours (4 times the rate of a 20GB hard-disk drive).

Note: Set up the REC Time Mode when a multiplexer is connected.

If a multiplexer is connected, for optimum image recording and playback, the record speed of the multiplexer must be correctly adjusted to match the DVR and set the **MULTIPLEXER** option on the setup menu to **ON**. This can be done by either of the two methods detailed below.

- (1) If an APPRO multiplexer is connected for use, you can program the REC time mode of the multiplexer by referring to the table below (each refresh rate refers to one REC time mode).
- (2) For a multiplexer other than APPRO, please connect the SW. OUT terminal in the 9-PIN D-SUB connector on the rear panel of the DVR to the multiplexer's trigger contact. The DVR will provide the timing signal (Negative/Falling) to the multiplexer. Thus, if the DVR changes the recording speed, the multiplexer will automatically adjust the record to match. A 2-hour and 4-hour timing signal in NTSC or a 3-hour and 6-hour one in PAL is constantly negative / falling.

OPERATIONS (continued)

| NTSC (MUX ON) | | | | | | | | | | | | |
|--------------------------|----------|---|------|------|-------|-------|-------|-------|--------|--------|--------|--------|
| Audio ON (11KHz) | | Possible Recording Time HDD=20GB (hour) | | | | | | | | | | |
| Image Quality | BEST | 3.5 | 4.4 | 6.6 | 11.0 | 23.6 | N.A. | N.A. | N.A. | N.A. | N.A. | N.A. |
| | HIGH | 3.5 | 5.5 | 8.3 | 13.7 | 29.2 | N.A. | N.A. | N.A. | N.A. | N.A. | N.A. |
| | STANDARD | 3.7 | 7.4 | 11.0 | 18.1 | 38.2 | N.A. | N.A. | N.A. | N.A. | N.A. | N.A. |
| | BASIC | 5.5 | 11.0 | 16.4 | 26.7 | 55.3 | N.A. | N.A. | N.A. | N.A. | N.A. | N.A. |
| Refresh Rate (Field/Sec) | | 60 | 30 | 20 | 12 | 5.5 | 2.4 | 1.22 | 0.71 | 1/4 | 1/6 | 1/8 |
| REC Time Mode | | 2 hr | 4 hr | 6 hr | 12 hr | 24 hr | 48 hr | 96 hr | 168 hr | 480 hr | 720 hr | 960 hr |

| NTSC (MUX ON) | | | | | | | | | | | | |
|--------------------------|----------|---|------|------|-------|-------|-------|-------|--------|--------|--------|--------|
| Audio OFF | | Possible Recording Time HDD=20GB (hour) | | | | | | | | | | |
| Image Quality | BEST | 3.6 | 4.5 | 6.7 | 11.3 | 24.8 | 56.5 | 110.7 | 192.1 | 544.7 | 816.0 | 1087.3 |
| | HIGH | 3.6 | 5.6 | 8.4 | 14.1 | 31.0 | 70.6 | 138.4 | 240.1 | 680.9 | 1020.0 | 1359.1 |
| | STANDARD | 3.7 | 7.5 | 11.3 | 18.8 | 41.1 | 94.1 | 184.6 | 320.2 | 907.9 | 1360.0 | 1812.2 |
| | BASIC | 5.6 | 11.3 | 16.9 | 28.2 | 62.1 | 141.2 | 276.9 | 480.3 | 1361.9 | 2040.1 | 2718.3 |
| Refresh Rate (Field/Sec) | | 60 | 30 | 20 | 12 | 5.5 | 2.4 | 1.22 | 0.71 | 1/4 | 1/6 | 1/8 |
| REC Time Mode | | 2 hr | 4 hr | 6 hr | 12 hr | 24 hr | 48 hr | 96 hr | 168 hr | 480 hr | 720 hr | 960 hr |

| NTSC (MUX OFF) | | | | | | | | | | | | |
|--------------------------|----------|---|------|------|-------|-------|-------|-------|--------|--------|--------|--------|
| Audio ON (11KHz) | | Possible Recording Time HDD=20GB (hour) | | | | | | | | | | |
| Image Quality | BEST | 3.5 | 4.4 | 8.8 | 13.2 | 25.7 | N.A. | N.A. | N.A. | N.A. | N.A. | N.A. |
| | HIGH | 3.5 | 5.5 | 11.0 | 16.4 | 31.7 | N.A. | N.A. | N.A. | N.A. | N.A. | N.A. |
| | STANDARD | 3.7 | 7.4 | 14.6 | 21.6 | 41.4 | N.A. | N.A. | N.A. | N.A. | N.A. | N.A. |
| | BASIC | 5.5 | 11.0 | 21.6 | 31.7 | 59.7 | N.A. | N.A. | N.A. | N.A. | N.A. | N.A. |
| Refresh Rate (Field/Sec) | | 60 | 30 | **20 | **12 | **5.5 | 2.4 | 1.22 | 0.71 | 1/4 | 1/6 | 1/8 |
| REC Time Mode | | 2 hr | 4 hr | 6 hr | 12 hr | 24 hr | 48 hr | 96 hr | 168 hr | 480 hr | 720 hr | 960 hr |

| NTSC (MUX OFF) | | | | | | | | | | | | |
|--------------------------|----------|---|------|------|-------|-------|-------|-------|--------|--------|--------|--------|
| Audio OFF | | Possible Recording Time HDD=20GB (hour) | | | | | | | | | | |
| Image Quality | BEST | 3.6 | 4.5 | 9.0 | 13.5 | 27.1 | 58.7 | 113.0 | 194.4 | 547.0 | 818.3 | 1089.5 |
| | HIGH | 3.6 | 5.6 | 11.3 | 16.9 | 33.9 | 73.4 | 141.2 | 243.0 | 683.8 | 1022.8 | 1361.9 |
| | STANDARD | 3.7 | 7.5 | 15.0 | 22.6 | 45.2 | 97.9 | 188.3 | 324.0 | 911.7 | 1363.8 | 1815.9 |
| | BASIC | 5.6 | 11.3 | 22.6 | 33.9 | 67.8 | 146.9 | 282.5 | 486.0 | 1367.6 | 2045.7 | 2723.9 |
| Refresh Rate (Field/Sec) | | 60 | 30 | **20 | **12 | **5.5 | 2.4 | 1.22 | 0.71 | 1/4 | 1/6 | 1/8 |
| REC Time Mode | | 2 hr | 4 hr | 6 hr | 12 hr | 24 hr | 48 hr | 96 hr | 168 hr | 480 hr | 720 hr | 960 hr |

| PAL (MUX ON) | | | | | | | | | | | | |
|--------------------------|----------|---|------|------|-------|-------|-------|-------|--------|--------|--------|--------|
| Audio ON(11KHz) | | Possible Recording Time HDD=20GB (hour) | | | | | | | | | | |
| Image Quality | BEST | 3.5 | 5.3 | 8.0 | 13.2 | 23.2 | N.A. | N.A. | N.A. | N.A. | N.A. | N.A. |
| | HIGH | 3.5 | 6.6 | 9.9 | 16.4 | 28.7 | N.A. | N.A. | N.A. | N.A. | N.A. | N.A. |
| | STANDARD | 4.4 | 8.8 | 13.2 | 21.6 | 37.6 | N.A. | N.A. | N.A. | N.A. | N.A. | N.A. |
| | BASIC | 6.6 | 13.2 | 19.5 | 31.7 | 54.4 | N.A. | N.A. | N.A. | N.A. | N.A. | N.A. |
| Refresh Rate (Field/Sec) | | 50 | 25 | 17 | 10 | 5.5 | 2.9 | 1.52 | 0.88 | 1/4 | 1/6 | 1/8 |
| REC Time Mode | | 3 hr | 6 hr | 9 hr | 12 hr | 24 hr | 48 hr | 96 hr | 168 hr | 480 hr | 720 hr | 960 hr |

| PAL (MUX ON) | | | | | | | | | | | | |
|--------------------------|----------|---|------|------|-------|-------|-------|-------|--------|--------|--------|--------|
| Audio OFF | | Possible Recording Time HDD=20GB (hour) | | | | | | | | | | |
| Image Quality | BEST | 3.6 | 5.4 | 8.1 | 13.5 | 24.4 | 46.1 | 89.5 | 154.6 | 545.2 | 816.5 | 1087.7 |
| | HIGH | 3.6 | 6.7 | 10.1 | 16.9 | 30.5 | 57.6 | 111.8 | 193.2 | 681.5 | 1020.6 | 1359.7 |
| | STANDARD | 4.5 | 9.0 | 13.5 | 22.6 | 40.6 | 76.8 | 149.1 | 257.7 | 908.7 | 1360.8 | 1812.9 |
| | BASIC | 6.7 | 13.5 | 20.3 | 33.9 | 61.0 | 115.2 | 223.7 | 386.5 | 1363.1 | 2041.2 | 2719.4 |
| Refresh Rate (Field/Sec) | | 50 | 25 | 17 | 10 | 5.5 | 2.9 | 1.52 | 0.88 | 1/4 | 1/6 | 1/8 |
| REC Time Mode | | 3 hr | 6 hr | 9 hr | 12 hr | 24 hr | 48 hr | 96 hr | 168 hr | 480 hr | 720 hr | 960 hr |

| PAL (MUX OFF) | | | | | | | | | | | | |
|--------------------------|----------|---|------|------|-------|-------|-------|-------|--------|--------|--------|--------|
| Audio ON(11KHz) | | Possible Recording Time HDD=20GB (hour) | | | | | | | | | | |
| Image Quality | BEST | 3.5 | 5.3 | 10.6 | 15.7 | 25.7 | N.A. | N.A. | N.A. | N.A. | N.A. | N.A. |
| | HIGH | 3.5 | 6.6 | 13.2 | 19.5 | 31.7 | N.A. | N.A. | N.A. | N.A. | N.A. | N.A. |
| | STANDARD | 4.4 | 8.8 | 17.4 | 25.7 | 41.4 | N.A. | N.A. | N.A. | N.A. | N.A. | N.A. |
| | BASIC | 6.7 | 13.5 | 27.1 | 40.6 | 67.8 | N.A. | N.A. | N.A. | N.A. | N.A. | N.A. |
| Refresh Rate (Field/Sec) | | 50 | 25 | **17 | **10 | **5.5 | 2.9 | 1.52 | 0.88 | 1/4 | 1/6 | 1/8 |
| REC Time Mode | | 3 hr | 6 hr | 9 hr | 12 hr | 24 hr | 48 hr | 96 hr | 168 hr | 480 hr | 720 hr | 960 hr |

| PAL (MUX OFF) | | | | | | | | | | | | |
|--------------------------|----------|---|------|------|-------|-------|-------|-------|--------|--------|--------|--------|
| Audio OFF | | Possible Recording Time HDD=20GB (hour) | | | | | | | | | | |
| Image Quality | BEST | 3.6 | 5.4 | 10.8 | 16.2 | 27.1 | 48.8 | 92.2 | 157.3 | 547.9 | 819.2 | 1090.4 |
| | HIGH | 3.6 | 6.7 | 13.5 | 20.3 | 33.9 | 61.0 | 115.2 | 196.6 | 684.9 | 1024.0 | 1363.1 |
| | STANDARD | 4.5 | 9.0 | 18.0 | 27.1 | 45.2 | 81.3 | 153.7 | 263.2 | 913.2 | 1365.3 | 1817.4 |
| | BASIC | 6.7 | 13.5 | 27.1 | 40.6 | 67.8 | 122.0 | 230.5 | 393.3 | 1369.8 | 2048.0 | 2726.2 |
| Refresh Rate (Field/Sec) | | 50 | 25 | **17 | **10 | **5.5 | 2.9 | 1.52 | 0.88 | 1/4 | 1/6 | 1/8 |
| REC Time Mode | | 3 hr | 6 hr | 9 hr | 12 hr | 24 hr | 48 hr | 96 hr | 168 hr | 480 hr | 720 hr | 960 hr |

NOTE: Recording times on the tables above are estimated. For actual available recording time of a recording configuration, please refer to the system information of the DVR. (Please refer to section 2.3 system information for more details.)

NOTE: There is no audio function at the refresh rate in NTSC: 2.4 fields/sec ~ 1 fields/ 8 sec. There is no audio function at the refresh rate in PAL: 2.9 fields/sec ~ 1 fields / 8 sec.

NOTE: An actual recording field number could be less than the Refresh Rate on the table above.

** : In the NTSC and Mux Off mode, a recording rate of 20F/S would be actually 15 F/S, 12F/S would be 10 F/S and 5.5 F/S would be 5F/S.

** : In the PAL and Mux Off mode, a recording of rate 17F/S would be actually 12.5 F/S, 10F/S would be 8.3 F/S and 5.5 F/S would be actually 5F/S.

(This adjustment is to avoid image shaking during playback at the same speed.)

3.2 Recording Operations

This section details the way to record video into hard-disk drives. Before commencing with the recording function, please configure the recording setting properly according to your needs.

3.2.1 Manual Recording

Take the following steps to start and stop recording:

- (1) Press the **REC** button ^⑥ to record video into a hard-disk drive with the corresponding programmed recording settings. The **REC** button ^⑥ will light up indicating the DVR is in the recording status.
- (2) Press the **REC** button ^⑥ for 3 seconds to stop recording any time.
- (3) To access just recorded video, please refer to section 3.4 for more details.

3.2.2 Timer Recording

Timer recording provides 2 periods of time each day in a weekly table which programs the DVR to turn on and off at specified times. This way the DVR will start/ stop recording according to the programmed schedule.

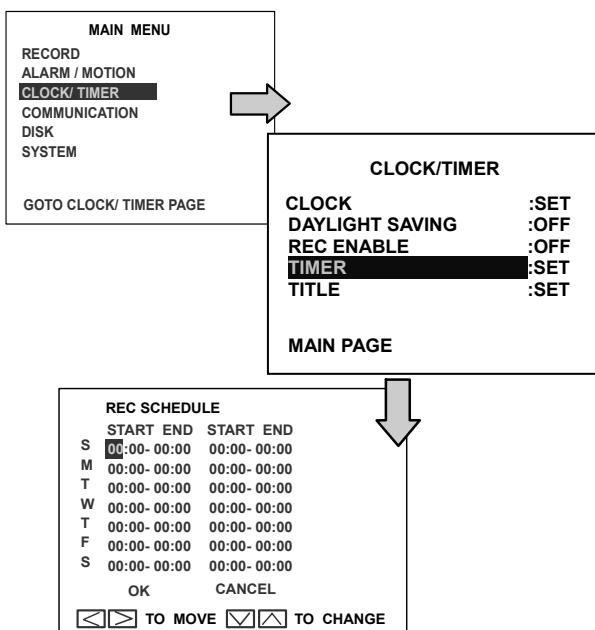

- (1) Press the **Setup** button ^⑨ to enter the **MAIN MENU**.

- (2) Select the **CLOCK / TIMER** and press the **Enter** button ^⑮ to enter the **CLOCK / TIMER** page.
- (3) Select the **TIMER – SET**.
- (4) Press the **Enter** button ^⑮ to enter the **REC SCHEDULE** table.
- (5) You can set up by using the “<” button ^⑪ and the “>” button ^⑭ to locate the specific day/hour/minute and use the “^” button ^⑫ and the “v” button ^⑬ to set the day/hour/minute you wish.
You can also set up by using the **Shuttle Ring** and the **Jog Dial**. [Ⓢ] is the equal of the “<” button ^⑪, [Ⓡ] is the equal of the “>” button ^⑭, [Ⓚ] is the equal of the “^” button ^⑫ and [Ⓛ] is the equal of the “v” button ^⑬.
The time is displayed in a 24-hour clock format.

- (6) After scheduling is completed, press the **Enter** button ^⑮ and set **OK** to save the setting or select **CANCEL** to leave the page without saving.
- (7) To activate/ deactivate the programmed recording schedule, set the **REC ENABLE** to **ON/ OFF**. If the scheduled recording is on, the red indicator of the Timer Record ^⑰ will be on as well.

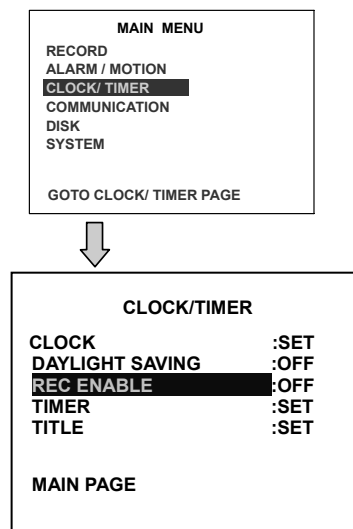

- (8) Press the **REC** button ^⑥ for 3 seconds

during the scheduled recording to stop it any time. If you wish to continue the scheduled recording, press the **REC** button (6) to proceed.

Note : You can proceed to start the scheduled recording from the current time if it is in the scheduled interlude as soon as setting is completed, and come out from the menu to start recording.

Note : If you activate the recording function before the scheduled recording, the unit will operate recording as shown in the diagram below and keep those Images in different files.

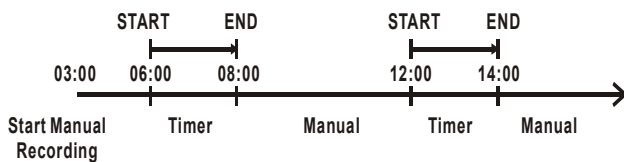

3.2.3 Alarm / Motion Recording

Take the following steps to activate the programmed alarm recording. For the **ALM OPERATION**, **REC RATE**, **REC QUALITY**, **AUDIO**, **ALM TYPE**, **ALM DURATION**, and **PRE-ALARM** settings, please refer to section 4.2 for more details.

- (1) Press the **Setup** button (9) to enter the **MAIN MENU**.
- (2) Select **ALARM / MOTION** and press the **Enter** button (15) to enter the **ALARM / MOTION**.
- (3) Set the desired **REC RATE**, **REC QUALITY**, **ALM TYPE**, and **ALM DURATION** for use. If audio is required, set **AUDIO** to **ON**. If pre-alarm recording is required, set **PRE-ALARM** to **ON**.
- (4) To activate/deactivate the alarm recording, set **ALM OPERATION** to **ON/ OFF**.

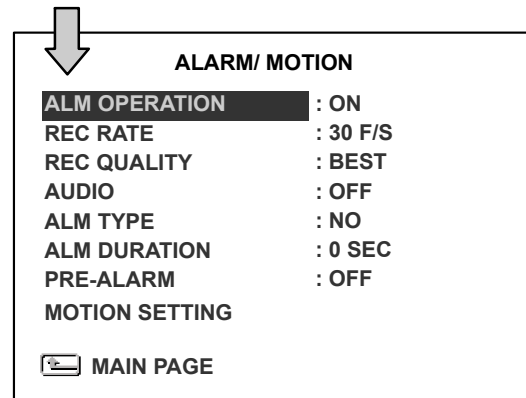
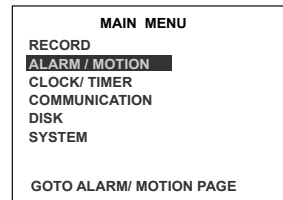

- (5) To active the motion alarm recording, select **MOTION SETTING** and press the **Enter** button (15) to enter the **MOTION SETTING PAGE**, set **MOTION ENABLE TO ON**, and set a suitable **SENSITIVITY** and **REGION** according to the video sources.

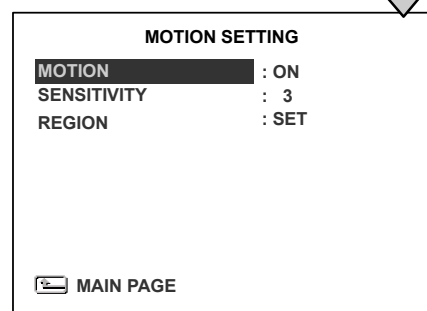
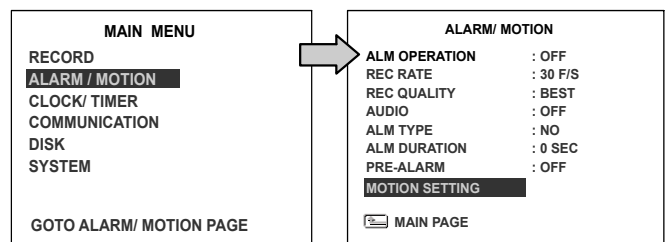

3.2.4 Externally Triggered Recording

By connecting/ disconnecting **RECORD IN** of **ALARM I/O** on the rear panel of the DVR, you can activate/deactivate the recording function of a DVR. The file will be kept with a prefixed **"R"**.

NOTE: The status of recording operations when an alarm takes place is shown in the diagrams below.

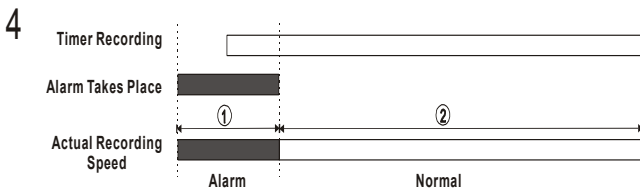
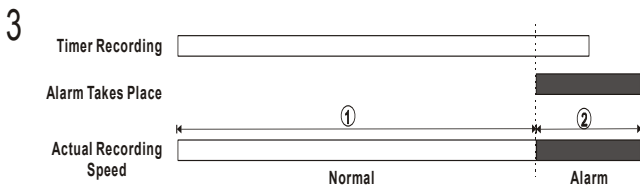
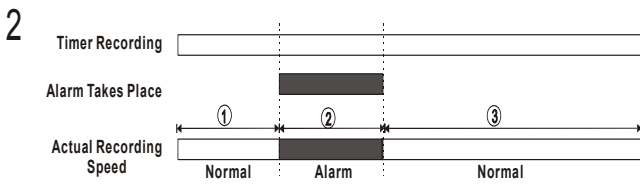
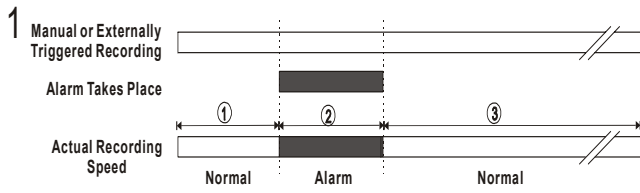

3.3 Playback Operations

This section shows you how to operate the fast, slow, and single-picture playback functions, and details how the unit is to playback a file in a different operation status. Please refer to the following paragraphs specifying the relevant details. When playing a file, the monitor should display a flashing **PLAY** message and the **PLAY** button  will light up indicating that the DVR is in the playback status.

3.3.1 Normal Playback

Once the user presses the **PLAY** button, the DVR will start playing back the recorded data at the recorded speed. The starting position varies according to different operation sequences.

A. Play back from the latest playback **STOP** position.

[**PLAY**] - [**STOP**] - [**PLAY**]

B. Play back from the latest recorded video.

[**REC**] - [**PLAY**] or

[**REC**] - [**REC Stop**] - [**PLAY**]

C. Play back from a video clip in Search List.

[**Search**] - [**PLAY**]

D. Play back from the start of hard disk recorded data.

[**STOP** - press the key for 3 sec.] - **PLAY**

Once playback reaches the end of an HDD's recorded data, the DVR will show a message signaling the recording's end (use the **SEARCH** functions or rewind to replay the file if required) .

3.3.2 Fast Forward/Backward

There are **7** speeds available for playback: 1x, 2x, 4x, 8x, 16x, 30x and 100x.

While playing back recorded video at the recorded speed:

Forward: Turn the **Shuttle** dial  to the right to view the recorded video in the forward direction at a speed faster than the recorded speed. Each subsequent turn of the shuttle to the right increases the forward rate, as 2x, 4x, 8x, 16x, 30x and 100x.

Backward: Turn the **Shuttle** dial  to the left to view the recorded video in the reverse direction at a speed faster than the recorded speed. Each subsequent turn of the shuttle to the left increases the reverse rate, as -1x, -2x, -4x, -8x, -16x, -30x and -100x.

Normal: Release the **Shuttle** dial  to return to the normal speed of playback.

NOTE: While Normal playing a recorded video from a multiplexer at 60 F/S~30F/S (50F/S~25F/S for PAL), the playback speed is half the recorded speed.

NOTE: The playback speed will be displayed on the screen. However, when playing a recorded video from a multiplexer, the playback speed will only display in encoding (multiplexing) the mode. Press the **Monitor** button  to switch between decoding and encoding modes.

3.3.3 Slow Forward/Reverse

There are **4** speeds available for a slow playback: 1/2, 1/4, 1/8, 1/16.

While playing back recorded video at the recorded speed:

- (1) Press the **PAUSE** button **(3)** for the slow playback mode.
- (2) **Forward:** Turn the **Shuttle** dial **(20)** to the right to view the recorded video in the forward direction at a speed slower than the recorded speed. Each subsequent turn of the shuttle to the right increases the forward rate, as 1/2, 1/4, 1/8, and 1/16.
- (3) **Reverse:** Turn the **Shuttle** dial **(20)** to the left to view the recorded video in the reverse direction at a speed slower than the recorded speed. Each subsequent turn of the shuttle to the left increases the reverse rate, as -1/2, -1/4, -1/8, and -1/16.
- (4) **Normal:** Release the **Shuttle** dial **(20)** and then press the **PLAY** button **(4)** to return to the normal speed of playback.

3.3.4 Play back Picture-by-picture

While playing back recorded video at the recorded speed:

- (1) Press the **PAUSE** button **(3)** for the picture-by-picture mode.
- (2) There are two ways, by **PAUSE** button or by **JOG**, available to play in the picture-by-picture mode, but the **PAUSE** button **(3)** can only function in a forward direction; the other, **JOG** dial **(21)**, can act in both a forward and a backward direction, as well as picture-by-picture.

A. By **PAUSE** button **(3)**:

Press the **PAUSE** button **(3)** to display one frame/field of a picture at a time in the forward direction. **(When playing back video recorded by a multiplexer, each sequential press of the PAUSE button **(3)** will display each camera in sequence.)**

B. By **JOG** dial **(21)** :

Turn the **JOG** dial **(21)** clockwise to display one frame/field of a picture at a time in the forward direction. Turn the **JOG** dial **(21)** counterclockwise to display one frame/field of a picture at a time in the backward direction.

- (3) Press the **PLAY** button **(4)** to return to the normal speed of playback.

3.3.5 Playback Recorded Video from an HDD of the mobile rack (for removable HDD model only)

To play back a recorded video from an HD2, take the following steps:

- (1) Press the **Search** button **(10)** to enter the search mode.
- (2) Press the **“^”** **(12)** and **(13)** **“v”** buttons to select a video; press the **(11)** **“<”** and **(14)** **“>”** buttons to flip over a page.
- (3) Use the search function to access desired recorded video. For specific operation details please refer to the next section **3.4** (Search Operations).

3.3.6 Picture in Picture (PinP) Display Mode

While playing back recorded video, the display mode can be switched to **2** different PinP mode by pressing the **DISPLAY**

button **8**. This function is available only when the **MUX** option has been set to **OFF**.

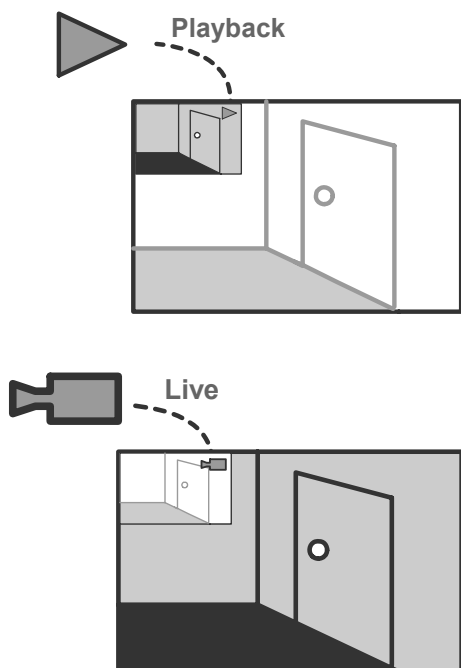

When the DVR is under PinP display mode, please use the “<”, “>”, “v”, “^” **11** ~ **14** buttons to move the position of the small windows as your desire.

3.4 Search Operations

This section shows you how to access recorded video.

Note: The **Search** button has another special function. You can press and hold it down for over 3 seconds. The **REVIEW TEXT** mode will then be activated. The **REVIEW TEXT** page has 6 items for selection. Please refer to **Chapter 6** for more details.

3.4.1 FULL LIST Search

Take the following steps to proceed with the full-list search function.

- (1) Press the **Search** button **10** to enter the search mode.
- (2) Select the **FULL LIST** and press the **Enter** button **15** to access the complete list of

recorded video.

- (3) Highlight the specific recorded video you require and press the **Enter** button **15** to display the selected video.

(Key Operation: Press the “^” **12 and “v” **13** buttons to select a video; press the **11** “<” and **14** “>” buttons to flip over a page.)**

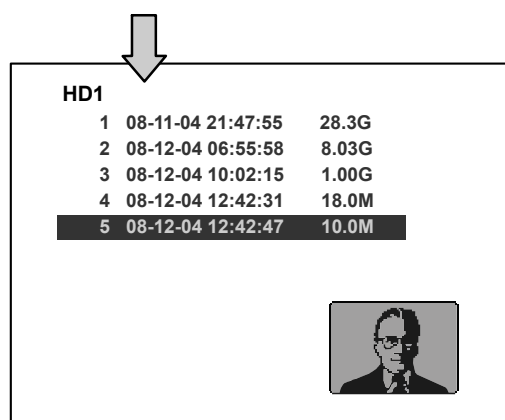
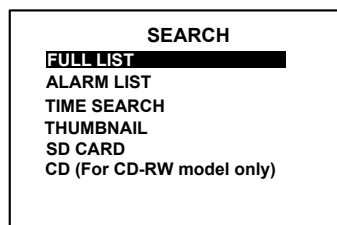

NOTE: T: Timer recording; R: External trigger recording; A: Alarm recording.

NOTE: The maximum number of index in the list, for a respective HDD, is 3000.

3.4.2 ALARM LIST Search

Take the following steps to proceed with the alarm-list search function.

- (1) Press the **Search** button **10** to enter the search mode.
- (2) Select the **ALARM LIST** and press the **Enter** button **15** to access the complete list of alarm-event recorded video.
- (3) Highlight the specific recorded video you require and press the **Enter** button **15** to display the selected video.

(Key Operation: Press the “^” **12 and “v” **13** buttons to select a video; press the **11** “<” and **14** “>” buttons to flip over a page.)**

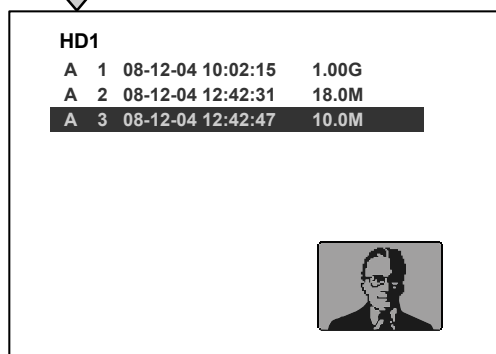
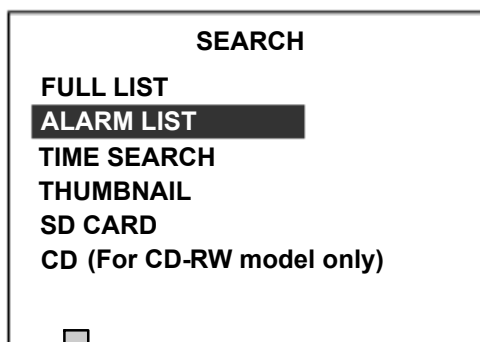

3.4.3 TIME Search

Take the following steps to proceed with the time-list search function.

- (1) Press the **Search** button (10) to enter the search mode.
- (2) Select the **TIME SEARCH** and press the **Enter** button (15) to access the time-setting page.
- (3) Set the time period you wish to search for the recorded video.
- (4) Press the **Enter** button (15) to start searching and displaying the concerned image.
- (5) If no video is found, please return to the time-setting page and repeat steps (3) and (4) again for another search.

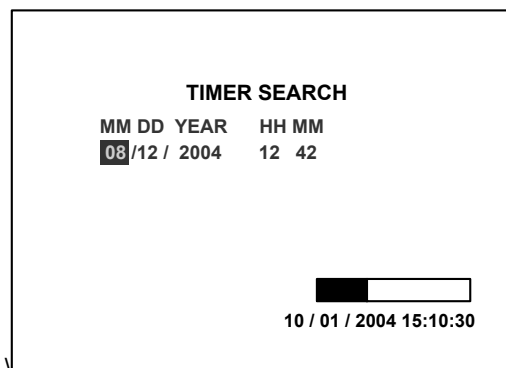
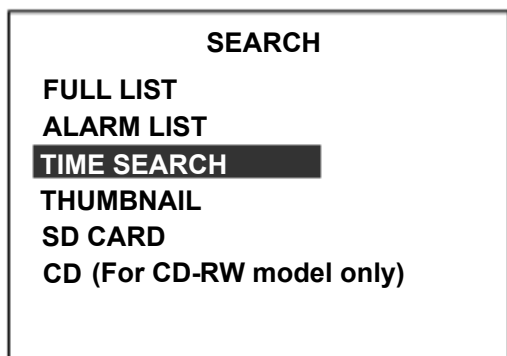

3.4.4 THUMBNAIL Search

Take the following steps to proceed with the thumbnail search function.

- (1) Press the **Search** button (10) to enter the search mode.
- (2) Select the **THUMBNAIL** and press the **Enter** button (15) to access the thumbnail page.
- (3) Set the date you wish to search for the recorded video.
- (4) Press the **Enter** button (15) to start searching and displaying the concerned image.
 - You can set up by using the “<” (11) “>” (14) “^” (12) “v” (13) buttons to move focus.
 - You can also set up by using the **Shuttle Ring** and the **Jog Dial** to move eye focus.
 - ◀ is the equal of the “<” button (11), ▶ is the equal of the “>” button (14), ▲ is the equal of the “^” button (12) and ▼ is the equal of the “v” button (13).
- (5) There are **5** levels of recording range modes to choose from: **1 Hour, 10 Minutes, 1 Minute, 10 Seconds** and **1 Second**. Select the specific field you require and press the **Enter** button (15) to enter the next level. If you want to return to the previous level, please press the **Setup** button (9).
- (6) On reaching the critical point at any level,

the user can start playback by just clicking the **PLAY** button ④.

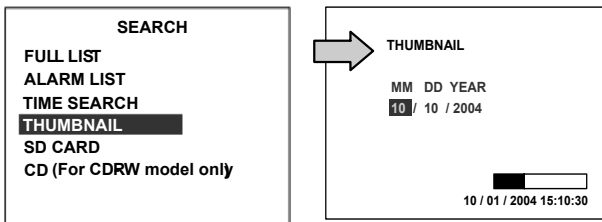

LEVEL 1 : Interval = 1 Hour

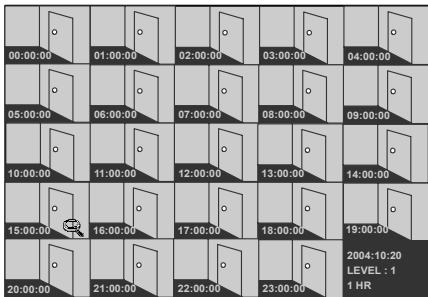

LEVEL 2 : Interval = 10 Min.



LEVEL 3 : Interval = 1 Min



LEVEL 4 : Interval = 10 Sec.

LEVEL 5 : Interval = 1 Sec.



3.4.5 SD CARD Search

Take the following steps to proceed with the SD card search function.

- (1) Insert an SD Card into the SD card slot of the rear unit.
- (2) Press the **Search** button ⑩ to enter the search mode.
- (3) Select the **SD CARD** and press the **Enter** button ⑮ to access the complete list of JPG files.
- (4) Highlight the specific JPG file you require and press the **Enter** button ⑮ to display the image.
- (5) If you need another, please return to the SD card JPG file list page and repeat steps 3 and 4 again for another search.

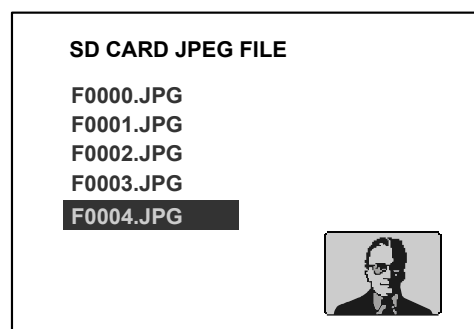
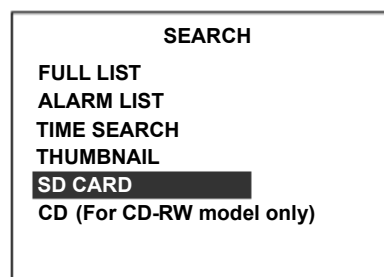

NOTE: To delete a JPG file in the SD card, please return to the SD CARD JPG FILE list page, and highlight the specific JPG file, press the Setup button⁹, then select “Yes” to delete the image.

3.4.6 CD Menu (For CD-RW model only)

Take the following steps to proceed with the CD search function.

- (1) Place the disc in the tray.
- (2) Press the **Search** button ¹⁰ to enter the search mode.
- (3) Select the **CD** option and press the **Enter** button ¹⁵ to access the complete list of JPEG files.
- (4) Highlight the specific JPEG file you require and press the **Enter** button¹⁵ to display the image.
- (5) If you need another, please press the **Enter** button ¹⁵ to return to the **CD MENU** page and repeat step (4) again for another search.

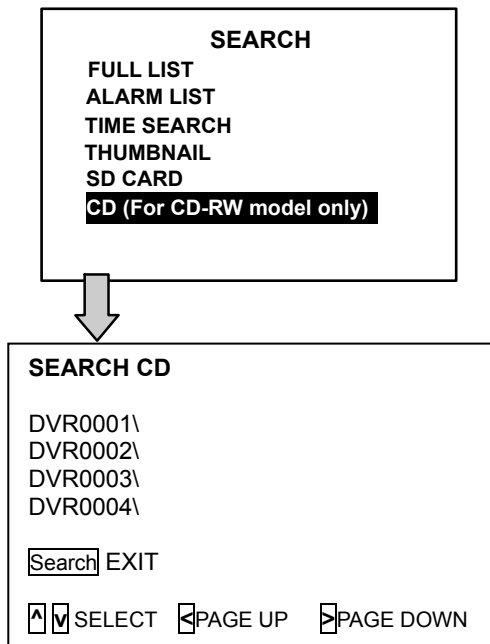

(“CD” STANDS FOR THE CD-ROM MODEL AND “BACKUP” IS FOR THE REMOVABLE HDD MODEL ONLY IN ITEM 6.)

NOTE: If by accident one selects a CD item and forgets to insert it: See the picture below for this status and please insert a CD or press the search button to exit the CD menu.

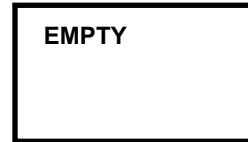

3.5 Backup Operations

3.5.1 CD Rewritable unit Backup Operations (FOR CD-ROM MODEL ONLY)

This device now includes a CD-RW unit.

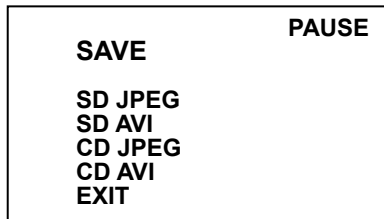

- (1) **SD JPEG:** Archive single image clips into an SD card.
 - i) Insert an SD Card into the SD card slot of the rear unit.
 - ii) Play the video back to find your desired item. Press **PAUSE** button when you find it.
 - iii) Press the **Seq./Save** button **16** and select # 1 ("**SD JPEG**").
 - iv) Press the **Enter** button **15** to save the image in the SD Card.
- (2) **SD AVI:** Archive video of AVI clips into an SD card.
 - i) Insert an SD Card into the SD card slot of the rear unit.
 - ii) Play the video back to find your desired item. Press **PAUSE** button when you find it.
 - iii) Press the **Seq./Save** button **16** and select # 2 ("**SD AVI**").
 - iv) Press the **Enter** button **15** to save the video in the SD Card.
- (3) **CD JPEG:** You can archive a lot of single images in a CD disc by entering this item. Please follow the steps given below.
 - i) Please insert the CD disc in its tray. You'll hear a signaling beep to tell you the disc is ready.
 - ii) Play the video back to find your desired item. Press **PAUSE** when you find it.

- iii) Press the **Seq./Save** button **16** and select # 3 ("**CD JPEG**") and enter.
- iv) You've entered the **CD JPEG** menu.
- v) Select item 1("**ADD**") to add your image into the buffer.

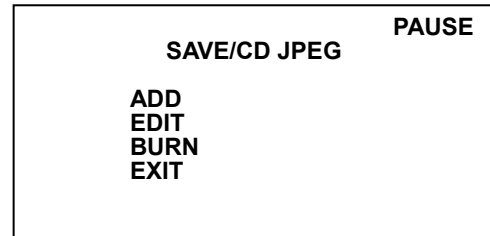

- vi) Turn the jog dial or Play button to find the next image you want. Now repeat the last step again to add this image to the buffer. You can continue in this way indefinitely.
 - vii) If you now wish to edit your buffer, select item 2 ("**EDIT**") in the **CD JPEG** menu. Now in the **EDIT jpeg** page, press " < ", " > ", " v " and " ^ " buttons to review your selected images. As the images move, you can decide to delete or not delete any image you find unnecessary or not by pressing the "**Setup**" buttons to "**NO**" (meaning no deletions) or "**YES**" (meaning you're deleting a particular image). Press the "**Search**" button to exit this page.
 - viii) If your selection is complete, enter item 3 ("**BURN**") in the **CD JPEG** menu. Give the device some time to complete this process.
 - ix) Press the eject button to open the CD tray, take out the CD disc, and enter it in a PC to view your selections.
- (4) **CD AVI:** You can archive a video in the CD disc by entering this item. Please follow the steps given below.
 - i) Please insert the CD disc in its tray.

Hear that beeping signal to confirm your disc is ready.

- ii) Play the video back to find your desired item. Press **PAUSE** when you want to start.
- iii) Press the **Seq./Save** button **16** and select # 4 ("**CD AVI**") and enter.
- iv) You're in the **CD AVI** menu now.
- v)

| | SAVE/CD AVI | PAUSE |
|------|-------------|-------|
| BURN | | 30S |
| BURN | | 1 M |
| BURN | | 3 M |
| BURN | | 5 M |
| BURN | | 10 M |
| EXIT | | |

Use the " v " and " ^ " buttons to select the time length of your saved recording between "30 seconds", "1M", "3M", "5M" and "10M". Then enter this item to start burning your video in the CD disc.

- vi) Press the eject button to open the CD tray, take out the CD disc, and enter it in a PC to view your video.

3.5.2 Mobile Rack HD Backup Operations (FOR REMOVABLE HDD MODEL ONLY)

There are **3** ways available to duplicate the recorded video from HD 1 (Fixed HD) to HD 2 (Mobile Rack HD). Please take the following steps to proceed.

- (1) **Set HD 2 to BACKUP first. Take the following steps.**
 - Press the **Setup** button **9** to enter the setup mode and select the **DISK**.
 - Highlight **DISK** and press the **Enter** button **15** to enter the **DISK SETTING** page.
 - Then set **HD 2 USAGE** to **BACKUP**.

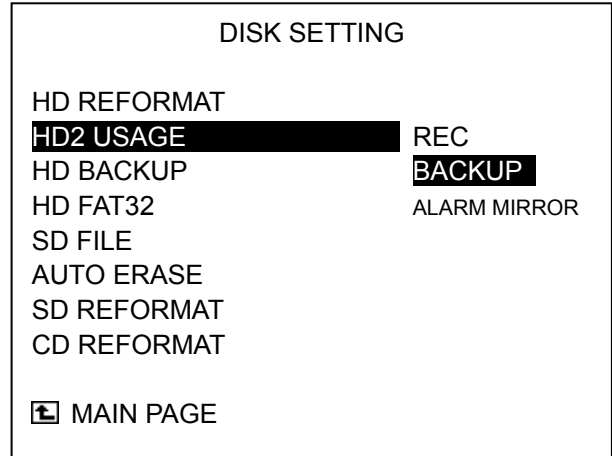
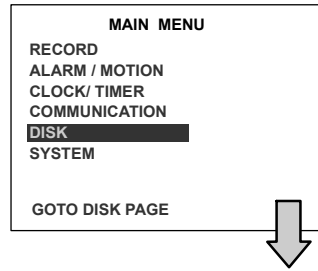

(2) FULL: Duplicate all the recorded video from HD1 to HD2.

On the **DISK SETTING** page, use the "**^**" **12** and "**v**" buttons and button **13** to highlight **HD BACKUP**, select **FULL**, then press the **Enter** button **15** to proceed.

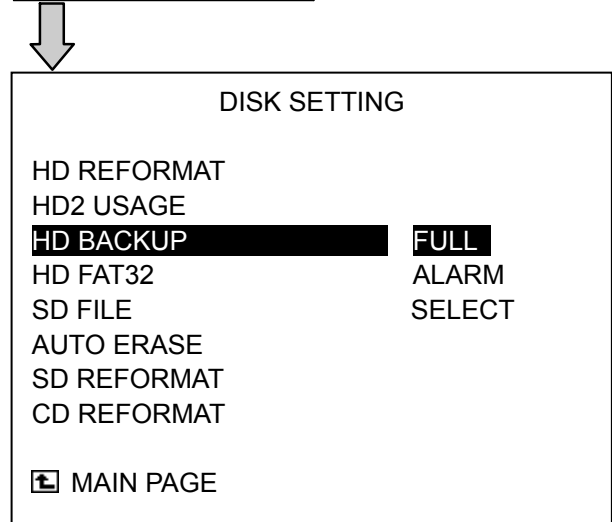
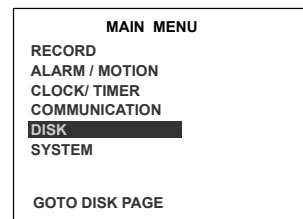

ALARM: Duplicate all the alarm-event

recorded video from HD 1 to HD2.

Stay on the **DISK SETTING** page.

Use the “▲” (12) and “▼” buttons and button (13) to highlight **BACKUP**; select **ALARM**, then press the **Enter** button (15) to proceed.

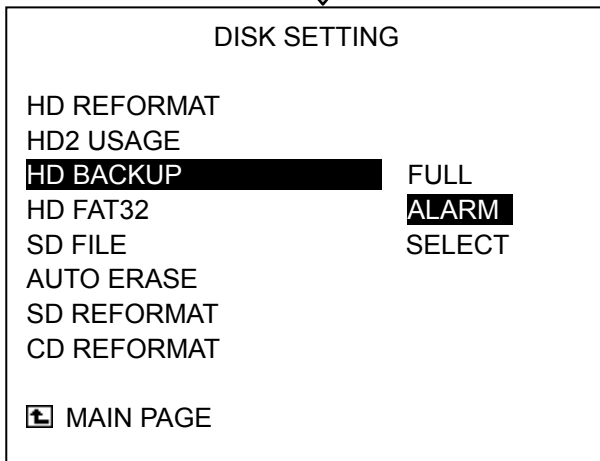
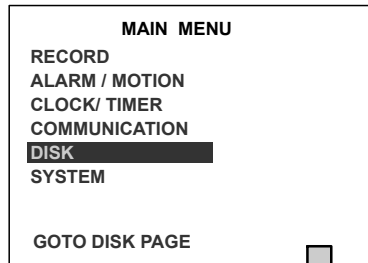

SELECT: Duplicate a particular recorded video from HD1 to HD2.

Stay on the **DISK SETTING** page.

Use the “▲” (12) and “▼” buttons (13), to highlight **HD BACKUP**, choose the “**SELECT**” item and then press the **Enter** button (15) to list all the recorded video.

Press the “▲” (12) and “▼” (13) buttons to select the desired clip and press the **Search** button (9) to mark it.

After completing the selection, press the **Enter** button (15) to proceed.

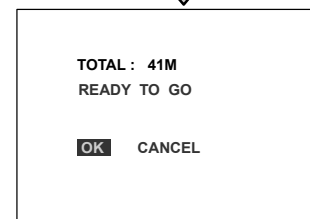
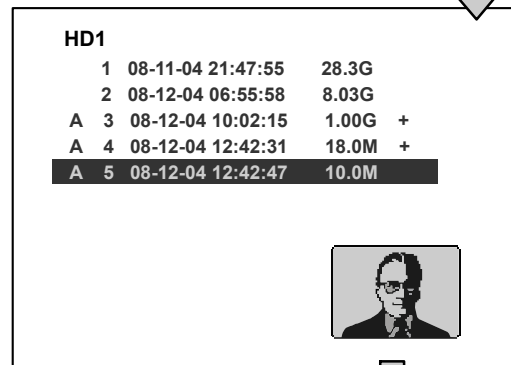
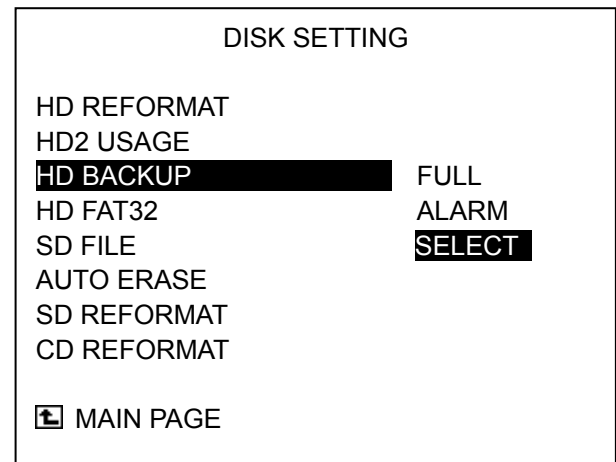
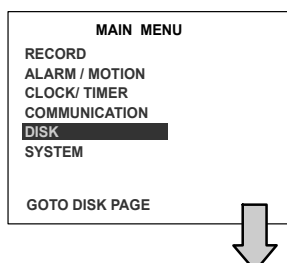

NOTE: If the capacity of HD 2 is not sufficient to store all selected video, a warning message “**HD2 SPACE NOT ENOUGH**” will be displayed on the screen. Please, insert a larger capacity of hard-disk drive and start the process all over again.

3.5.3 SD Card Backup Operations for Removable HDD Model

The SD card slot of the rear unit has four functions as shown below:

3.5.3.1 Archive Single image Clips into an SD Card

Please take the following steps to archive a critical image in an SD card.

- (1) Press the **Setup** button **(9)** to enter the setup mode and select the **DISK**.
- (2) Highlight **DISK** and press the **Enter** button **(15)** to enter the **DISK SETTING** page.
- (3) Then set **SD FILE** to **JPEG**.

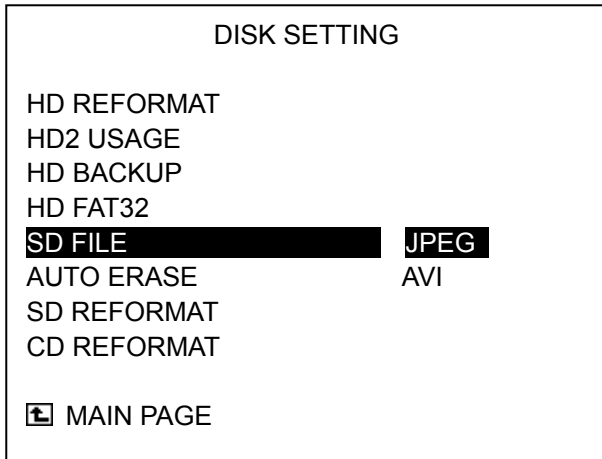

- (4) Insert an SD Card into the SD card slot of the rear unit.
- (5) Start playing back the recorded video.
- (6) Press the **PAUSE** button **(3)** to freeze the desired pictures.
- (7) Press the **Seq./Save** button **(15)** to save the image in the SD Card.

The quantity of pictures which can be stored depends on the SD card capacity. You can have the saved images printed out in any computer. The image is stored in the JPEG compressed format. If more than one clip is stored in an SD card, file names will be assigned in sequence as shown below.

SAVE TO F000.JPG
SAVE TO F001.JPG
 ...
SAVE TO F00N.JPG

- (5) If you have already saved the current picture on your screen. Then press **Seq./Save** **(16)** button to save.

3.5.3.2 Archive video of AVI clips into an SD card

Please take the following steps to archive a critical video in an SD card.

- (1) Press the **Setup** button **(9)** to enter the

setup mode and select the **DISK**.

- (2) Highlight **DISK** and press the **Enter** button **(15)** to enter the **DISK SETTING** page.
- (3) Then set **SD FILE** to **AVI**.

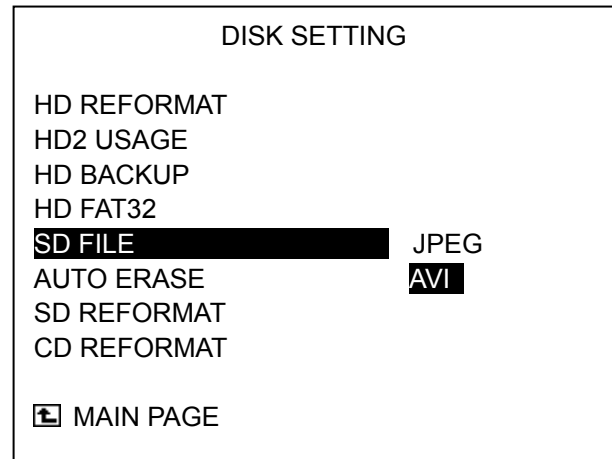

- (4) Insert an SD Card into the SD card slot of the rear unit.
- (5) Start playing back the recorded video.
- (6) Press the **PAUSE** button **(3)** to freeze the desired pictures.
- (7) Press the **Seq./Save** **(16)** button to save the video in the SD Card.

The quantity of video which can be stored depends on the SD card's capacity. The image is stored in the AVI compressed format. If more than one clip is stored in an SD card, file names will be assigned in sequence as shown below.

SAVE TO M000.AVI
SAVE TO M001.AVI
 ...
SAVE TO M00N.AVI

NOTE:

- The JPEG file format can be played and deleted in the DVR. Please refer to section 3.4.5.
- The AVI file format cannot be played and deleted in the DVR. It can only be played in a card reader connected to a computer.
- The file format can be selected from the "SD FILE" item in the Setup Menu. Please refer to section 4.5 for more detail.

3.5.4 Backup the System setting info into

an SD card.

The DVR offers a quick setup method by using the SD card. If a user wants to set many DVR devices with the same settings, the DVR could save the whole setting in the SD card, then transfer it to another DVR.

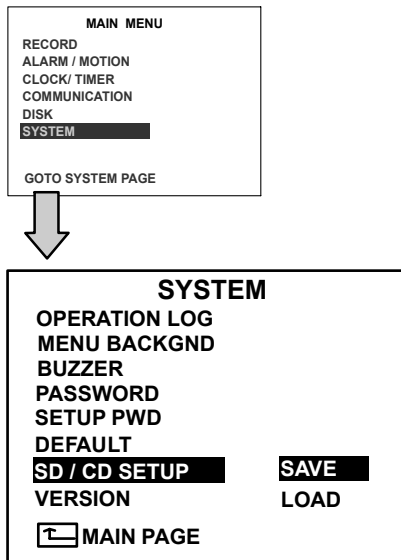

3.5.4.1 Save the whole setting into the SD card:

1. Insert an SD card into the SD card slot.
2. Press the **Setup** button (9) to enter the setup mode.
3. Highlight **SYSTEM** and press the **Enter** button (15) to enter the **SYSTEM SETTING** page.
4. Set **SD SETUP** to **SAVE**. Then the system setting info will auto save into SD card.

3.5.4.2 Transfer the system setting info of DVR to another:

1. Insert the SD card which has stored the system setting info into the DVR.
2. Press the **Setup** button (9) to enter the setup mode and select the **SYSTEM**.
3. Highlight **SYSTEM** and press the **Enter** button (15) to enter the **SYSTEM SETTING** page.
4. Then set **SD SETUP** to **LOAD**.

3.5.5 Updating System Software

Please refer to section 2.4 for more details.

3.6 Key Lock Operation

The Key lock operation protects the unit against unauthorized use by disabling the entire front panel controls. Simultaneously press these two (11) “<” and (14) “>” buttons for at least 3 seconds to lock the unit; to release the **Key Lock**, simultaneously press these two buttons again.

4. MENU SETUP

4. MENU SETUP

There are **6** categories for operation setting in the setup menu system as shown below. The following sections will instruct you step by step to configure the operation setting and state each menu's purpose and options. Press the **Setup** button ⑨ to access the setup menu. Once inside the menu system, the on-screen menu allows you to set up the key features of the unit. The functions of various buttons within the menu-setup mode are described in the paragraphs below.

KEY FUNCTIONS

Setup button ⑨ :

Press to enter the setup menu. Press again to exit the setup mode.

“▲” ⑫ and “▼” ⑬ buttons :

Press to select the desired item or entry for setting.

“<” ⑪ and “>” ⑭ buttons :

Press to highlight the desired option or to select the context for setting.

Enter ⑮ button :

Press to enter the selected item and to save the setting.

Shuttle Ring ⑳ :

Turn to highlight the desired option or to select the context for setting.

Jog Dial ㉑ :

Turn to select the desired item or entry for setting.

4.1 REC Setting

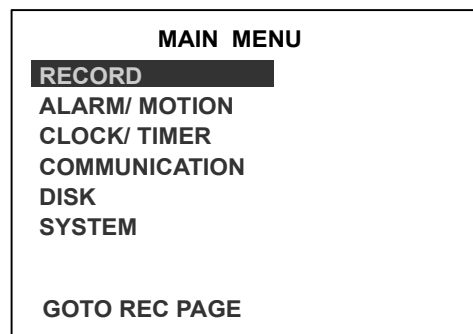

This page allows you to set the recording rate and recording quality, and enables you to continue recording when the disk is full.

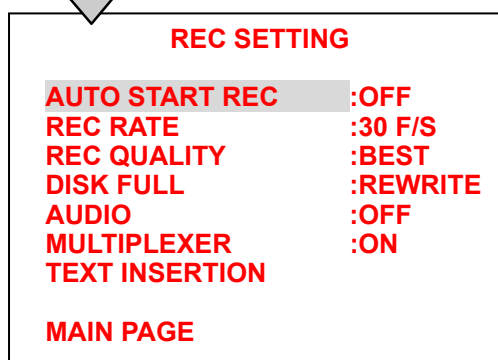
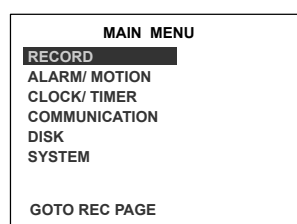

AUTO START REC:

This option determines the way to record automatically after power activated if necessary.

OFF: Disables it.

ON: Enables it.

REC RATE :

This option is for adjusting the number of pictures recorded every second into a storage disk. The recording rate controls the frequency at which the number of video pictures can be recorded.

- For an NTSC unit there are 11 different recording rates you can select from: **60F/S (60 fields per second), 30F/S, 20F/S, 12F/S,**

MENU SETUP (continued)

5.5F/S, 2.4F/S, 1.22F/S, 0.71F/S, 1 F/4S, 1F/6S, and 1F/8S.

- For a PAL unit there are 11 different recording rates you can select from: **50F/S (50 fields per second), 25F/S, 17F/S, 10F/S, 5.5F/S, 2.9F/S, 1.52F/S, 0.88F/S, 1 F/4S, 1F/6S, and 1F/8S.** Please refer to the table in section 3.1 for details.

NOTE: The 60 f/s (50 f/s for a PAL unit) recording rate can only function in a 352x240 (352x288 for a PAL unit) resolution.

REC QUALITY:

This option determines the image quality to be recorded. The DVR stores images in the compressed format and allows the image quality to be altered by the image size. There are 4 levels of image quality you can select from: **BEST, HIGH, STANDARD, and BASIC.** Selecting the BEST image for use provides higher-resolution recorded images, and normally takes up more storage space than a HIGH, STANDARD or BASIC image does.

DISK FULL:

This option determines the way to utilize storage media in case of a full disk.

REWRITE: When the hard disk is full, the device continues recording by displacing the old data.

STOP: When the hard -disk is full, the device will stop recording.

AUDIO:

This option determines the way to record sound if necessary.

OFF: Disables AUDIO recording.

11 KHz: Enables AUDIO recording.

22 KHz: Enables AUDIO recording.

NOTE: Audio function can only be activated at the following refresh rates in NTSC(PAL): 60(50), 30(25), 20(17), 10(10), 5.5(5.5) fields/sec.

MULTIPLEXER:

For optimum image recording please set this option to **ON** when the DVR is connected to a

multiplexer for use. Set this option to **OFF** when it is only connected to a single camera or Quad processor.

TEXT INSERTION:

Please refer to Chapter 6. **TEXT INSERTION FUNCTION** for more details.

NOTE: The Text Insertion activates both the text data and the channel information in a DVR, and the remote viewer software takes effect after this option has been turned on.

4.2 ALARM / MOTION Setting

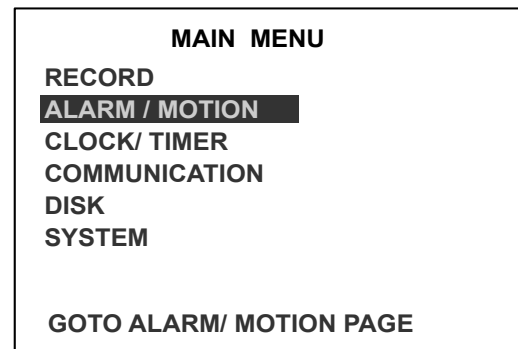

This menu allows users to program the configuration of alarm recording only when an alarm input is activated. The device will record as long as the alarm input is activated.

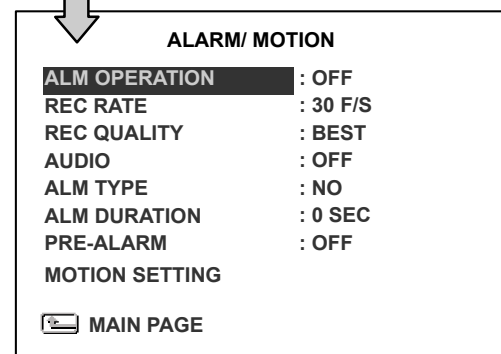
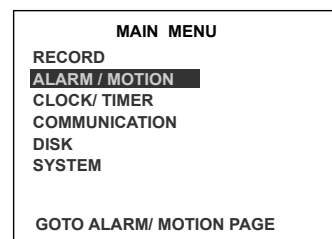

ALM OPERATION:

This option determines whether to activate

/ deactivate the alarm recording when it detects an alarm input.

ON: The device activates the alarm recording when it detects an alarm input.

OFF: The device ignores the alarm signal when it detects an alarm input.

REC RATE:

This option is for the purpose of adjusting the number of pictures recorded every second into a storage disk when an alarm input is activated. For an NTSC unit there are 5 different record speeds you can select from: **60F/S (60 fields per second), 30F/S, 20F/S, 12F/S, and REMAIN.** For a PAL unit there are 5 different record speeds you can select from: **50F/S (50 fields per second), 25F/S, 17F/S, 10F/S, and REMAIN.** If you select **REMAIN** for use, the device will record images at the same speed as set on the **REC** page.

REC QUALITY:

This option determines the image quality to be recorded when an alarm input occurs. There are 4 levels of image quality to choose from: **BEST, HIGH, STANDARD, and BASIC.** The table below shows the level of image quality with the corresponding compression ratio and image size.

| REC Quality | Best | High | Standard | Basic |
|-------------|------|------|----------|-------|
| Image Size | 48KB | 32KB | 21KB | 16KB |

AUDIO:

This option determines the way to record sound if necessary.

ON: Enables AUDIO recording.

OFF: Disables AUDIO recording.

NOTE: Audio function can only be activated at the following refresh rates in NTSC(PAL): **60(50), 30(25), 20(17), 10(10), 5.5(5.5) fields/sec.**

ALM TYPE:

This option allows users to set a type of alarm input corresponding to the sensor signal in use.

NO: Normally Open. This is to be used with the type of alarm sensor whose contact remains open in normal conditions and closes in case of activation.

NC: Normally Closed. This is to be used with the type of alarm sensor whose contact remains closed in normal conditions and opens in case of activation.

ALM DURATION:

This option allows users to set alarms for a certain duration. You can select one of the six following options: **0 SEC, 30SEC, 1 MIN, 5 MIN, 10 MIN, and NON-STOP.**

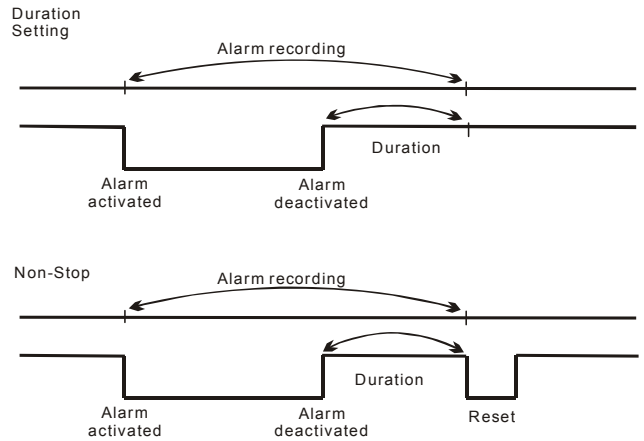

NOTE: Recording may be interrupted at the time of **Alarm-in or Alarm-out.**

LIVE images may be interrupted at the time of Alarm-out.

PRE- ALARM:

This option determines that images prior to an alarm will be recorded in the hard-disk drive. When an alarm is triggered the device will record the image prior to the alarm for 5 seconds (20 fields/sec).

ON: Enables this function.

OFF: Disables this function.

NOTE: If the device is already under recording mode before an alarm occur, the pre-alarm recording will not take effect.

MOTION SETTING:

The motion detection function is convenient for people without an alarm trigger input, but it can also be used with an alarm trigger input. If this function is enabled, object's movement will trigger the alarm recording just like the outside trigger signal. Before using the motion detection function, please turn the **ENABLE** option to **ON**, and set the **SENSITIVITY** (1 ~ 5) to a suitable value.

NOTE: The **MOTION ENABLE** option is not allowed set to **ON** when **MULTIPLEXER** option is set to **ON** in the **RECORD** page, it is because the motion detection function is for single camera only.

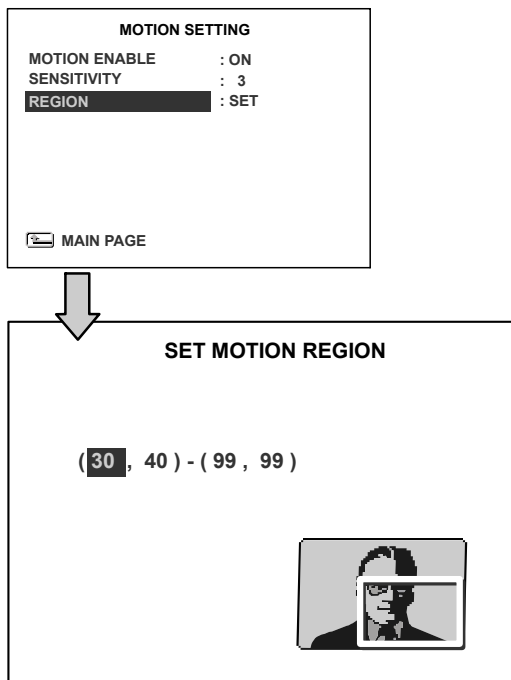

MOTION ENABLE:

This option enables / disables the motion detection.

ON: Enables the motion detection.

OFF: Disables the motion detection.

SENSITIVITY:

This option allows users to set the motion sensitivity. **1** is the most sensitive setting. **5** is the least sensitive setting.

REGION:

This option allows users to set the motion region.

4.3 CLOCK / TIMER Setting

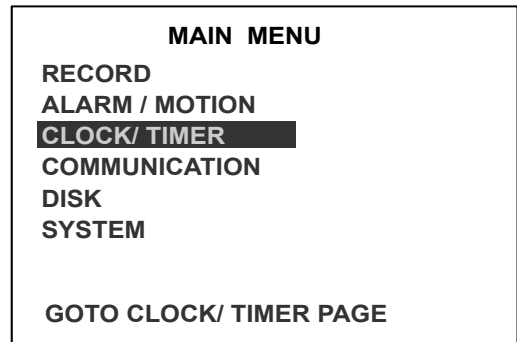

The DVR provides a weekly table consisting of two periods of time each day for scheduled recording. This option allows you to set the time each day when the DVR will start and stop recording.

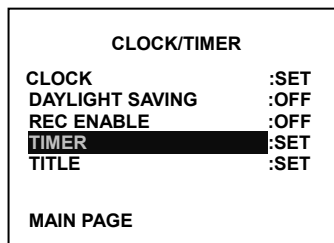
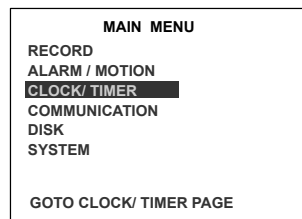

CLOCK:

This entry allows users to set the system time.

NOTE: Clock data is retained for about 3 months after the 15-hour power supply is used up (in the operate On mode).

DAYLIGHT SAVING:

This entry allows users to set the daylight saving time.

OFF: Disables the daylight saving time.

USA: Daylight saving time begins at 2:00 a.m. on the first Sunday of April. Time reverts to standard time at 2:00 a.m. on the last Sunday of October.

EUROPE (Except UK): Daylight saving time begins at 2:00 a.m. on the last Sunday of March. Time reverts to standard time at 2:00 a.m. on the last Sunday of October.

UK: Daylight saving time begins at 1:00 a.m. on the last Sunday of March. Time reverts to standard time at 1:00 a.m. on the last Sunday of October.

SET: to set the start and ending for the daylight saving time.

REC ENABLE:

This option enables/disables the programmed scheduled recording.

ON: Enables the scheduled recording.

OFF: Disables the scheduled recording.

TIMER:

This entry allows users to program the time each day when the DVR will start and stop recording. There are **2** time periods each day available for scheduling. The time is displayed in a 24-hour clock format. If there is a time overlapping showing between two continual time period settings, the device will automatically combine the two time-period settings into one.

```

REC SCHEDULE
START END START END
S 00:00- 00:00 00:00- 00:00
M 00:00- 00:00 00:00- 00:00
T 00:00- 00:00 00:00- 00:00
W 00:00- 00:00 00:00- 00:00
T 00:00- 00:00 00:00- 00:00
F 00:00- 00:00 00:00- 00:00
S 00:00- 00:00 00:00- 00:00
OK CANCEL
[←] [→] TO MOVE [↔] [↕] TO CHANGE
  
```

4.4 COMMUNICATION Setting

```

MAIN MENU
RECORD
ALARM / MOTION
CLOCK/ TIMER
COMMUNICATION
DISK
SYSTEM

GOTO COMM PAGE
  
```

This option allows you to configure the statuses of the RS-232 / RS485 communication ports when connected to external devices, and the Ethernet communications settings. Please refer to **6.1** RS-232/RS485 Protocols and **5.** Network Functions for more details.

```

MAIN MENU
RECORD
ALARM / MOTION
CLOCK/ TIMER
COMMUNICATION
DISK
SYSTEM

GOTO COMM PAGE
  
```



```

COMM SETTING

COMM ID :01
RS232 :ON
RS485 :ON
BAUD :2400
NET ENABLE :OFF
NET DHCP :OFF
NET IP :SET
NET ACCOUNT :SET
FTP SETTING

MAIN PAGE
  
```

COMM ID:

Communication ID for the RS232 and RS485 communication ports. After the DVR receives a RS232 or RS485 command, it checks if the <Dest ID> within the code is the same as the COMM ID, in which case the particular command can be accepted.

RS-232:

The RS-232 communication port can be either in an importing or exporting mode according to your applications.

ON: Enables the RS-232 communication port.

When you wish the unit to be controlled by an external device, please select this entry for use.

OFF: Disables the RS-232 communication port.

RS-485:

The RS-485 communication port can be either in an importing or exporting mode according to your applications.

ON: Enables the RS-485 communication port.

When you wish the unit to be controlled by an external device, please select this entry for use.

OFF: Disables the RS-485 communication port.

BAUD:

You have the option of using a Baud rate (at 8 different levels : **2400, 4800, 9600, 19200, 28800, 38400, 57600** or **115200**).

NET ENABLE:

This option enables or disables the Ethernet communication port.

OFF: Disables it.

ON: Enables it.

NET DHCP:

This option enables or disables the Ethernet communication port.

OFF: Disables it.

ON: Enables it.

NOTE: If provided with a DHCP server, the DVR can get an IP automatically by setting this option to ON.

NET IP:

This option is used to configure the Ethernet communication settings. This is required for the purpose of making a network connection. Please consult with a qualified MIS professional to configure it.

IP: XXX.XXX.XXX.XXX

MASK: XXX.XXX.XXX.XXX

GATEWAY: XXX.XXX.XXX.XXX

HTTP PORT: XXXX

NET ACCOUNT:

| COMM SETTING | |
|--------------|-------|
| COMM ID | :01 |
| RS232 | :ON |
| RS485 | :ON |
| BAUD | :2400 |
| NET ENABLE | :OFF |
| NET DHCP | :OFF |
| NET IP | :SET |
| NET ACCOUNT | :SET |
| FTP SETTING | :SET |
| MAIN PAGE | |



| NET ACCOUNT | |
|-----------------|----------|
| USERNAME | PASSWORD |
| ADMIN [admin |] [9999] |
| VIEW [view |] [0000] |
| SET NET ACCOUNT | |

FTP SETTING:

This entry allows users to set the FTP File Transfer Protocol.

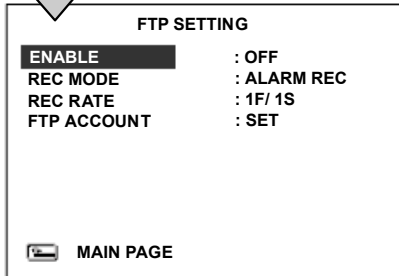
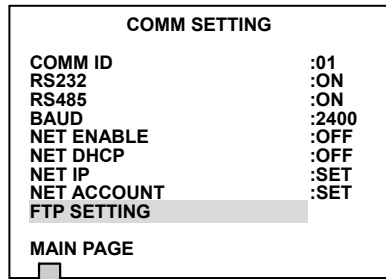

ENABLE:

This option is to select enable or disable for the FTP function.

ON: Enables it.

OFF: Disables it.

REC MODE:

This option determines the recording mode to be recorded when the FTP function occurs. There are 2 levels of recording mode to choose from: **ALARM REC** and **ALL REC**.

ALARM REC: Only to record the alarm-event recorded video.

ALL REC: To record all the recorded video.

REC RATE:

This option determines the recording rate to be recorded at when the FTP function occurs.

There are 4 levels of recording rates to choose from: **1 F / 1 S**, **1 F / 10 S**, **1 F / 30 S** and **1 F / 60 S**.

FTP ACCOUNT:

This option is used to configure the FTP account settings. This is required for the purpose of making an FTP connection. Please consult with a qualified MIS professional to configure it.

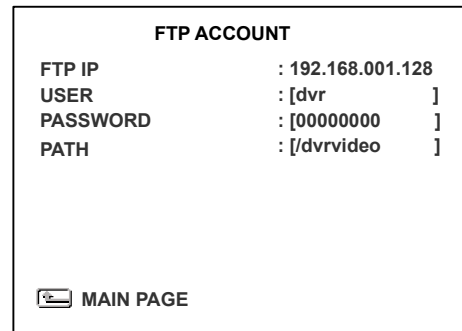

FTP IP

Every FTP server has to own an IP address to be identified on the network. Input the IP address of the FTP server.

USER

Type in the FTP user name (Login Name).

PASSWORD

Enter the FTP password (Password).

PATH

Enter the upload path while connecting the FTP.

4.5 DISK Setting

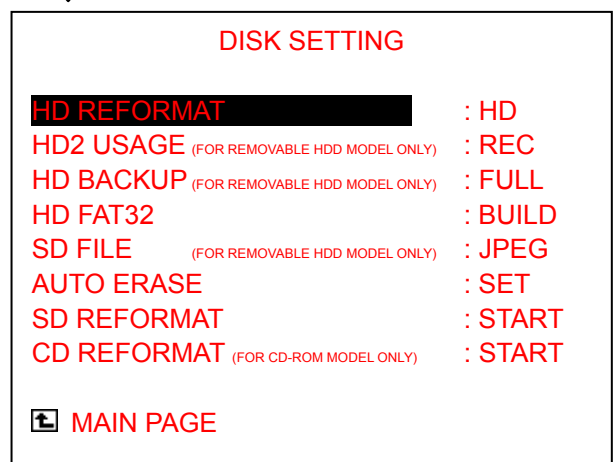
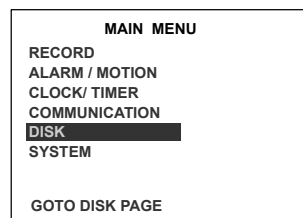

HD REFORMAT:

This option allows you to clear out all the data in the hard-disk drive. You will be required to enter the pre-set password before proceeding with

clearing out the data. Enter the standard password "9999" if you haven't set your own individual password. To set your individual password, please refer to section 4.6 **System Setting - PASSWORD** option.

HD 1 / 2: Clears out all the data stored in HD 1 and HD 2.

BACKUP HD: Clears out all the data stored in HD 2, which is set to backup purpose only. (This function has to be proceeded with when the **HD 2 USAGE** option is set to **BACKUP**.)

NOTE: In the case of the CD-RW model, only one HD can be reformatted. No backup HD can be used.

HD2 USAGE:

This option determines the way to utilize the hard-disk drive in the mobile compartment.

REC: Used for the regular recording hard-disk drives.

BACKUP: Used for data backup only, which will not be part of regular recording hard-disk drive.

ALARM MIRROR : The mirror function serves HD1. As HD1 records alarm data, that data is simultaneously written to HD2.

NOTE: In the case of the CD-RW model, no backup HD can be used. So you won't see that item mentioned in the menu.

HD BACKUP:

This function allows you to duplicate data from HD 1 to HD 2. Please set HD 2 as **BACKUP** first. (For operation details, please refer to section 3.5)

FULL: Duplicates all the recorded video from HD1 to HD2.

ALARM: Duplicates all the alarm-event recorded video from HD 1 to HD2

SELECT: Duplicates a particular recorded video from HD1 to HD2.

NOTE: In the case of the CD-RW model, no backup HD can be used. So you won't see that item mentioned in the menu.

HD FAT32:

This function builds the FAT32 file system a the hard-disk, enabling the data in it to be played back on the PC.

SD FILE:

This option determines the format to save the important image files in an SD card.

JPEG: Archives images in the JPEG format to save a single picture in every file.

AVI: Archives images in the AVI format to save a sequence of images in a file, the maximum limit being 300 images for every file. You can stop recording whenever you want, and if you don't, recording will automatically stop at the optimum of **300** images.

NOTE: In the case of the CD-RW model you won't see the "SD FILE" item mentioned in the menu, because it's not used here.

NOTE: To save images or videos in a CD-ROM or SD Card, please refer to section 3.5 for more details.

AUTO ERASE:

This item offers you two options.

OFF: Choosing this alternative disables the "AUTO ERASE" function.

SET: This choice enables the "AUTO ERASE" function. Select "SET" and press the **ENTER** button to enter the "AUTO ERASE SETTING" page, where you can enable the settings to save data for storage for any period of time from **1** to **365** days. After the expiry of the time period you set, the data will be erased automatically. This process of storage and erasure over the time period you set will be repeated indefinitely until you disable the settings or change the settings to a different time period.

SD REFORMAT:

This option allows you to clear out all the data in the SD card.

CD REFORMAT:

This option allows you to clear out all the data in the CD-ROM.

NOTE: In the case of the model with the removable HDD you won't see the "CD REFORMAT" item mentioned in the menu, because this model doesn't have a CD-ROM unit.

4.6 SYSTEM Setting

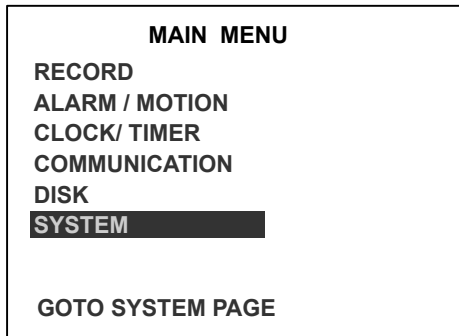

This page is used for accessing the history of the operation statuses, setting the password, resuming factory default, and determining the menu display background.

OPERATION LOG:

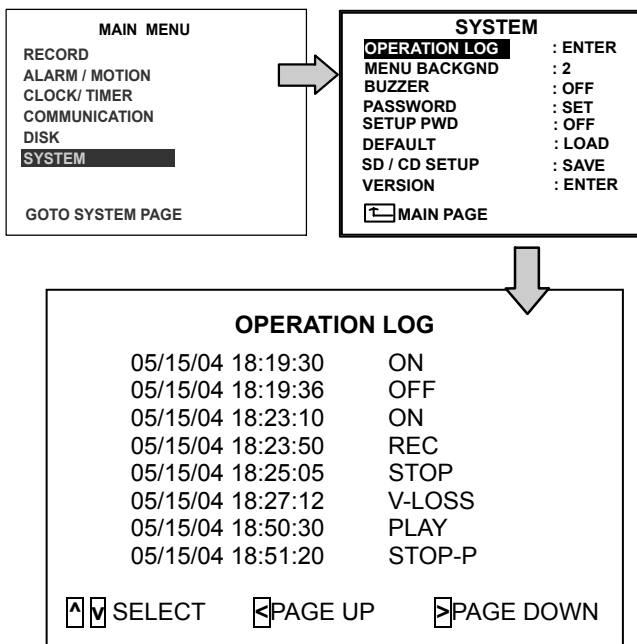

This log shows the history of the operation statuses in chronological order. What the following entries represent is detailed below.

- ON:** Switches on the device.
- OFF:** Turns off the device.
- REC:** Starts recording.
- STOP:** Ceases recording.
- STOP-P:** Ceases playback.
- PLAY:** Shows recorded video.

V-IN: Video input is connected.

V-LOSS: Video loss occurs.

P-LOSS: Power interruption occurs.

A-IN: Detects an alarm input.

LOCK: Disables the entire front panel controls.

UNLOCK: Releases the key lock.

UPDATE: Updates system software.

Note: The log keeps an operation history on a revolving basis because of a limit of 4000. When the log is full, the newly registered record of an operation will replace the existing records from the oldest one onwards.

MENU BACKGND:

There are **3** levels of background color transparency you can choose from: level 1 is totally transparent, level 3 is opaque, and level 2 is between levels 1 and 3. The background color is used in the setup menu and search function.

BUZZER:

This option determines the embedded buzzer sounding a tone to signal the following situations. A tone lasts about two seconds.

ON: Enables buzzer.

OFF: Disables buzzer.

Situation

Alarm occurs
 Video loss occurs
 Disk is full
 Load factory default
 Buzzer is set to ON
 Enables/disables the key lock function
 Power on /off in a mobile rack HDD
 Backup operation is complete
 Timer activates/deactivates
 Recording is switching between HDDs

PASSWORD:

This option allows you to set a password to

prevent any unauthorized re-formatting of the hard disk drives or use by a network viewer. The standard password is "9999".

OLD PASSWORD: Enter the pre-set password (or the standard password if this is the initial setting) to access the password setting system.

NEW PASSWORD: Enter a 4-digit-number password of your choosing which will replace the pre-set password (or the standard password "9999").

SETUP PWD:

When this option is on, the user must pass the password check before entering the setup menu.

ON: Enables pass protection for the setup menu.

OFF: Disables pass protection for the setup menu.

DEFAULT:

This option allows you to reload the factory default setting. Please do note that the password would not be changed in the factory default setting.

SD SETUP:

The DVR offers a quick setup method by using an SD card. If the user wants to set up a lot of the same devices with the same settings, he can save the whole settings to an SD card, then transfer them to another DVR.

SAVE: Saves the whole setting to the SD card.

LOAD: Loads the whole setting from the SD card.

VERSION:

This item is in the setup menu revealing the network MAC, the BIOS version, software version, and the last updated date.

MAC : 00:0C:0C:00:00:10
BIOS : 1.00
SW : 1.11GBT
DATE: Feb 24 2006

TEXT# : 186/ 65536

PRESS ENTER TO RETURN

5. NETWORK

5. NETWORK

5.1 Network Configuration

5.1.1 Cable Connections

Please follow the instructions below to connect your DVR to a computer or a network and to choose a proper RJ-45 cable configuration for connections.

Physical Spec. of RJ-45 Cable for Ethernet

| | |
|---------------------------------|------------------|
| Wire Type | Cat. 5 |
| Connector Type | RJ-45 |
| Max. Cable Length | 30 m |
| Hub Wiring Configuration | Straight Through |
| PC Wiring Configuration | Cross Over |

A. Connect to a PC

Use a crossover LAN cable to connect directly to a **PC**.

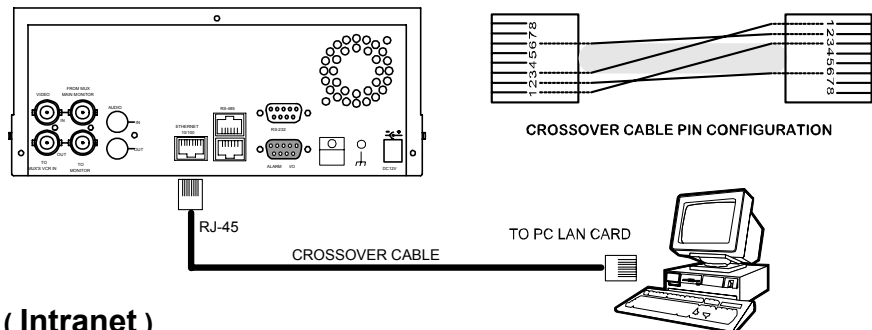

B. Connect to a LAN Hub (Intranet)

The RJ-45 PIN configuration for connecting with a LAN Hub is shown below.

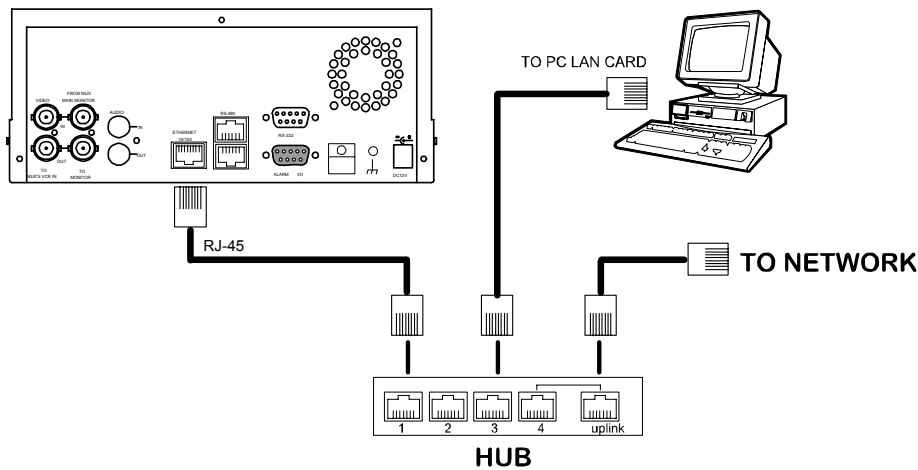

C. Connect to WAN (Internet)

The RJ-45 PIN configuration for connecting to a WAN is the same as that for connecting to a LAN.

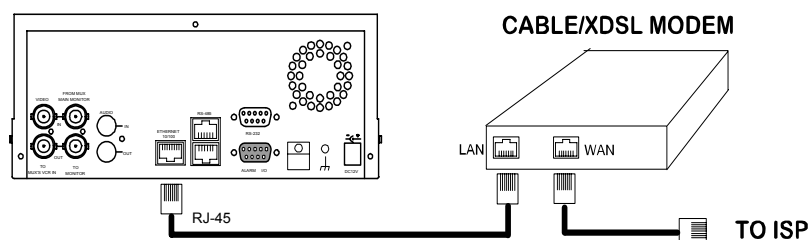

NETWORK (continued)

| PIN NO. | PIN Assignment |
|---------|----------------|
| 1. | TX + |
| 2. | TX - |
| 3. | RX + |
| 4. | Not Connected |
| 5. | Not Connected |
| 6. | RX - |
| 7. | Not Connected |
| 8. | Not Connected |

RJ-45 socket

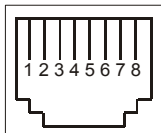

RJ-45 PIN configuration for LAN Hub

5.1.2 Configure Your DVR Network Settings

Upon network hardware connection, you need to activate the network function and configure the proper network settings of the DVR.

5.1.2.1 Enable DVR Network Function

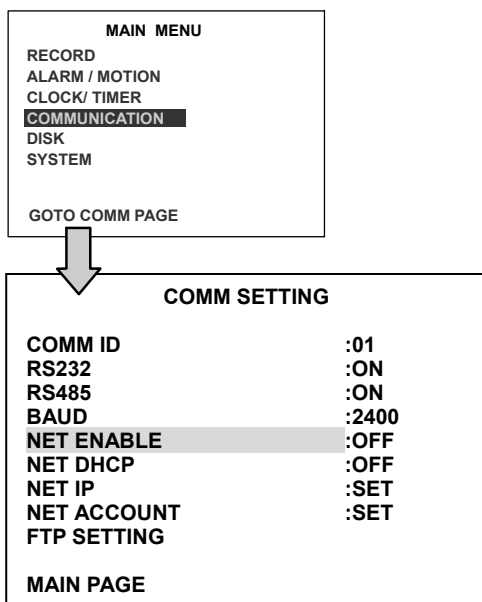

- Press the **Setup** button to enter the OSD MAIN MENU. Please use the “<” ⁽¹¹⁾ and “>” ⁽¹⁴⁾ buttons to highlight COMMUNICATION; then press the **Enter** button to enter the COMM SETTING page.

- Use the “▲” ⁽¹²⁾ “▼” ⁽¹³⁾ buttons to highlight NET ENABLE; select ON. Then press the **Enter** button to proceed.

5.1.2.2 Enable DHCP Function

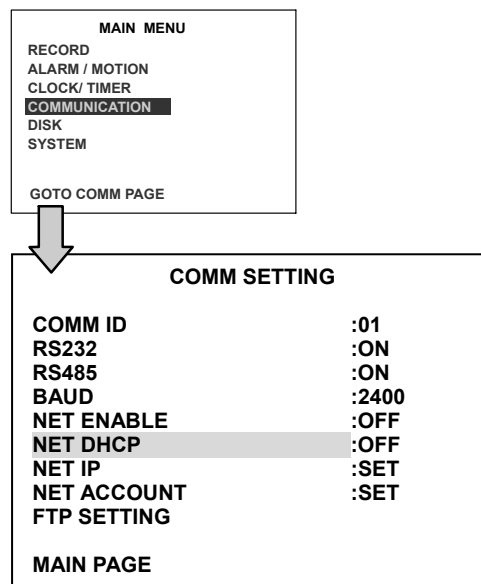

- Use the “▲” ⁽¹²⁾ and “▼” ⁽¹³⁾ buttons to highlight NET DHCP; select ON.

NOTE: This function can only work if the LAN which the unit is connected to has a DHCP server. If the DHCP server is working, the DVR will obtain an IP address automatically from the DHCP server. In that case please skip section 5.1.2.3 (Set IP address) and follow section 5.1.3 (TCP/IP Communication Software).

5.1.2.3 Set IP Address

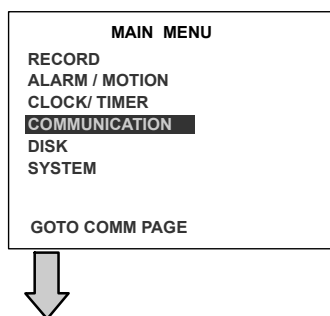

```

COMM SETTING

COMM ID      :01
RS232       :ON
RS485       :ON
BAUD        :2400
NET ENABLE   :OFF
NET DHCP    :OFF
NET IP      :SET
NET ACCOUNT :SET
FTP SETTING

MAIN PAGE

```

You don't need to set a NET IP for the unit if the LAN which the unit is connected to has a **DHCP server**. Otherwise, please follow the instructions given below:

Enter the NET IP page, and set the IP, MASK and GATEWAY. Then press the **Enter** button to proceed. The following is a sample setting.

```

IP:           192.168.1.100
MASK:        255.255.255.0
GATEWAY:     0.0.0.0
HTTP PORT:   80

```

NOTE:

1. When only one unit of the DVR is connected to a computer or LAN, you can freely assign an IP address for the DVR. For example, there is a range of DVR IP addresses from 192.168.1.1 to 192.168.1.255. You can pick one for use from the range of the IPs. It's not necessary to set MASK and GATEWAY; leave the settings as default.

When a DVR is connected to a WAN, you must acquire a unique, permanent IP address and correctly configure the MASK and GATEWAY settings according to your network architecture. If you have any questions regarding those settings, please contact a qualified MIS professional or your ISP.

2. Connecting to a network, each connected DVR must be assigned a unique IP, which must be in the same class type as your network address. IP addresses are written as four sets of numbers separated by periods: for example, 192.168.0.1 Therefore, if the connected network is identified as Class C, for example, the first three sets of numbers of the DVR IP address must be the same as the network address. If the connected network is identified as Class B, the first two sets of numbers of the DVR IP address must be the same as the network address. If you have any questions regarding these settings, please contact a qualified MIS professional or your ISP.

5.1.3 TCP/IP Communication Setup

Follow the instructions below to install the TCP/IP communication program into your computer.

1. Click the **Start** Menu from your computer, and point to the **Control panel**.



2. Click the **Network Connections** icon twice to enter the Network setting windows.

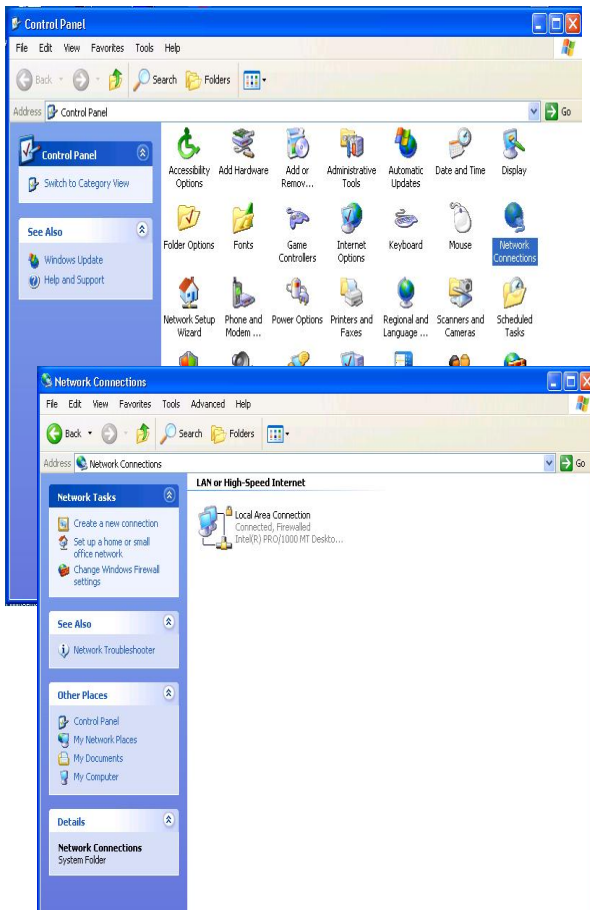

Point to the **Local Area Connection** and click the right bottom of the mouse. Click the **Properties** to enter the **Local Area Connection**.

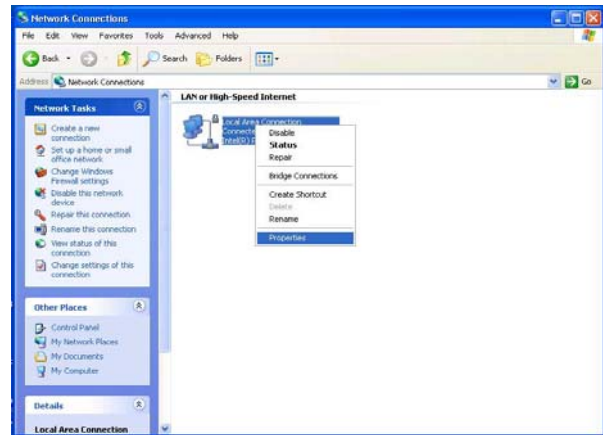

3. Click on the **Configuration** tag; check if the TCP/IP is included among the network component list. If the TCP/IP is included, please process step 5. If it is not included, please follow step 4 to install the TCP/IP.

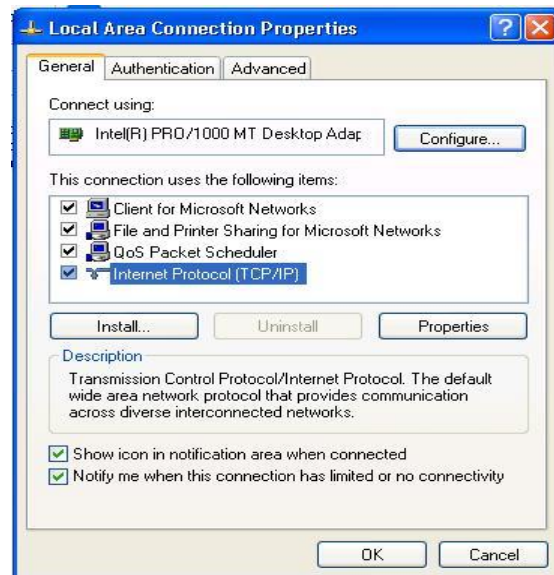

4. TCP/IP installation
During the installation, you will be requested to insert the windows XP CD ROM. After installation, the PC will be restarted.

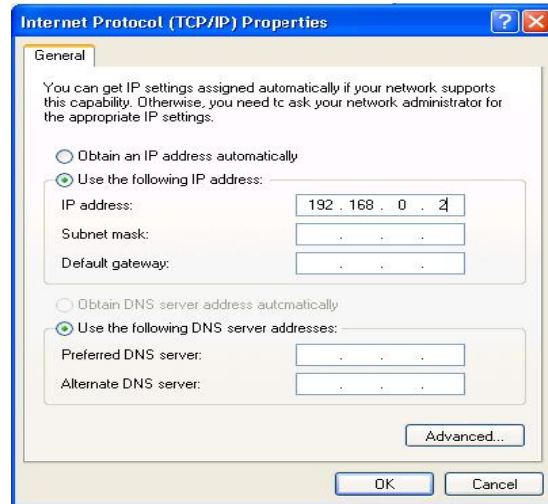
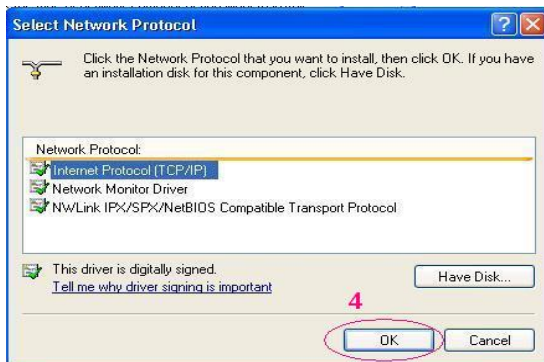
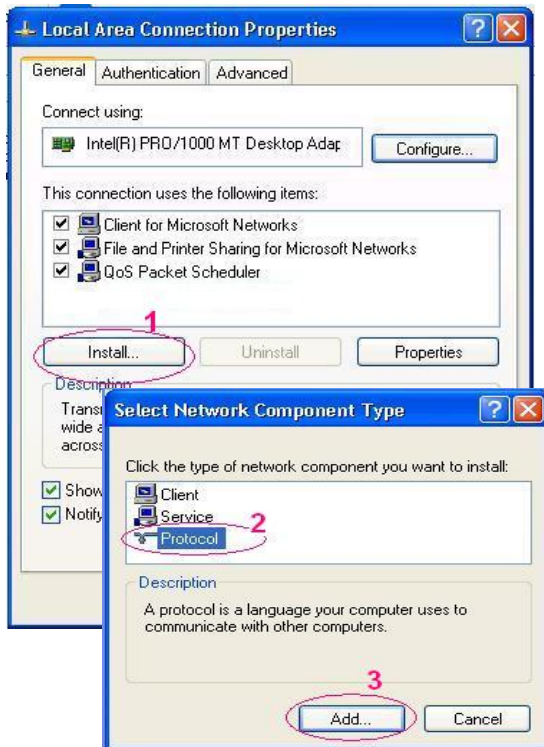

5. TCP/IP Configuration setting

- Click **Start** → **Control Panel** → **Network.Connections** → **Local Area Connection**
- Select **Internet Protocol (TCP/IP)**, and then click **Properties**.
- Before processing the DVR installation in a WAN, please make sure the Internet connection works properly. If not, please contact your ISP provider.

If you are using a DHCP server, please select “Obtain an IP address automatically”. Any assigned the IP address for the connected DVRs must be in the same class type as the server. If there is no DHCP server, please select and specify an IP address and type in the IP address of your PC. This IP address must be different from the DVR IP but in the same class type.

NOTE: The IP address of a DVR in a network must be unique to itself as opposed to those of the other chosen PCs, but in the same class type.

5.1.4 Testing Connection

With the previous settings, follow the instructions below to ensure whether you have established the connection successfully.

1. Click **Start → Command Programs**



2. Type in **ping 192.168.1.1** then Enter. (See the sample screen below)

** This IP is the DVR IP address that is assigned for the connected DVR.

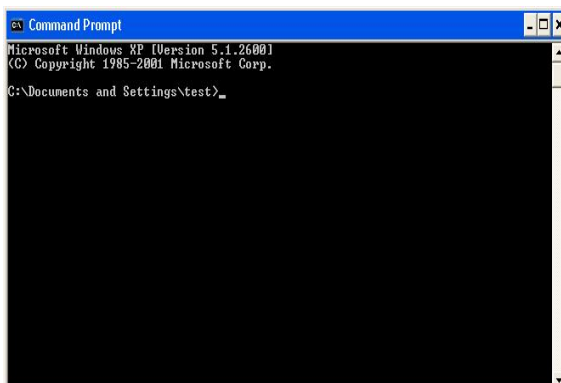

3. If you receive a response as in the sample screen below, the connection hasn't been successfully established. Please re-check all the hardware and software installation by repeating steps 1 to 5. If you still can't establish the connection after rechecking, please contact your dealer.

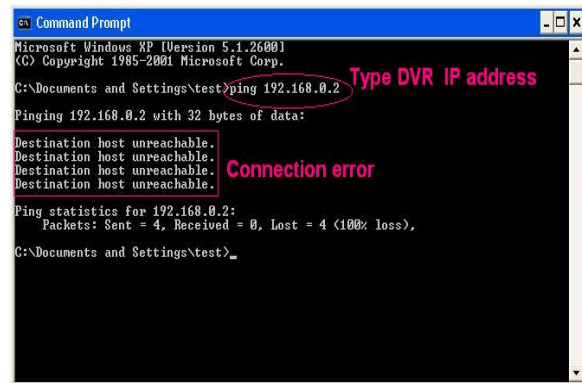

4. If you receive a response as in the sample screen below, you have successfully made the connection.

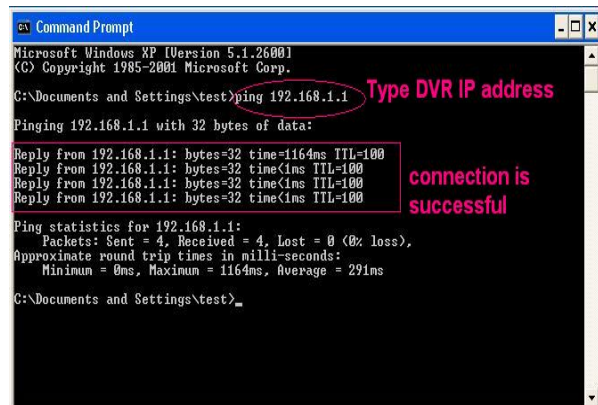

5.2 TRIPLEX 1 CH DVR VIEWER SOFTWARE: Introduction

This version of the TRIPLEX 1CH DVR Viewer Software uses the Microsoft .Net Framework version. The .Net Framework performs the XML Web Services, which applies this operation system. The .Net Framework provides a very high performance environment to solve the network program. Therefore, please use our Viewer Software to connect the TRIPLEX 1CH DVR. It will satisfy our users as being safer, faster, and more stable and reliable than other software. See below for the chief features of this Viewer Software :

1. This software supports the multiple functions of the network.
2. It can search as many DVRs as necessary.
3. It can support single display modes.
4. It has an extremely powerful search mode to help you search recorded data for the event / time you want.
5. It supports your local PC simultaneously with the DVR backup data.



The programs can be operated by a selected PC equipped with the following requirements :

1. Intel Pentium III 750MHz (at least).
2. 256 MB RAM.
3. Windows 98, NT, ME, 2000 and XP.
4. A 4 MB Video card capable of 24-bit true color display.
5. A 160 MB free hard-disk space for software installation.
6. A 10-base T network for LAN operation.

5.2.1 Software installation

Step 1 : Exit all applications currently running in the selected PC.

Step 2: Insert the supported PC in the CD - ROM device. The program will execute the installation of the .Net Framework automatically after you click the "**Setup.exe**" file.

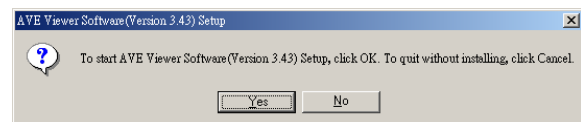

※Note: If you choose "**Yes**" in the above window, the installation will be completed automatically. You may need to wait 3 - 5 minutes during the installation.

Step 3: After you have completed installing the ".Net 1.0 Framework Viewer", you'll automatically enter the "**Viewer Software**" installation screen. Please see the screen below.

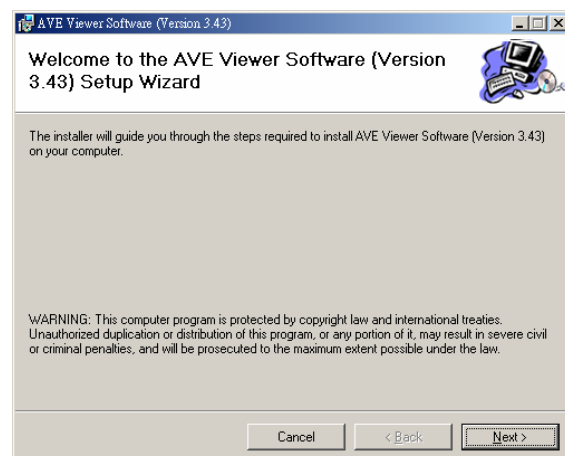

※**Note:** Please choose the **"Next"** button to continue.

Step 4: The installation screen will show the message **"C:\Program Files\AVE TECH\Viewer Software"**. Or you can select the path you want.

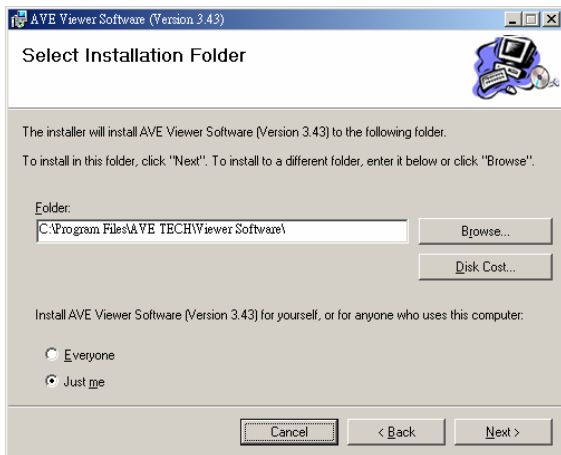

※**Note:** Click **"Next"** to continue the installation.

Step 5: The window below tells you the process is complete.

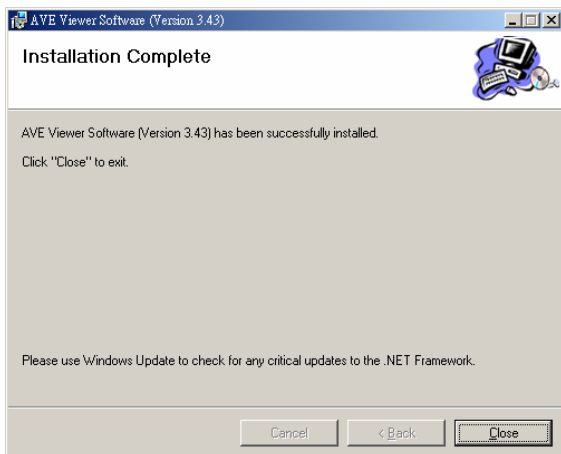

※**Note:** Click the **"Close"** button to complete the installation process.

Step 6: After completing installation, you can double - click the file shown below. Or click the **"Start Menu"** in the computer and select **"Programs"** to open the **"Program Selection"**

page. Then click the **"AVE Viewer Software"** tag to start the DVR Viewer Software Program.



5.2.2 Short introduction

Now the **"Login"** page appears. Enter the default **"User Name: admin"** and the **"Password: 9999"** in their respective entries, and click the **"Login"** button to log into the application.

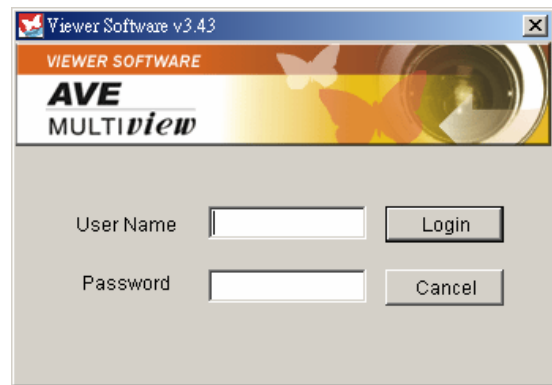

5.2.2.1 Program introduction

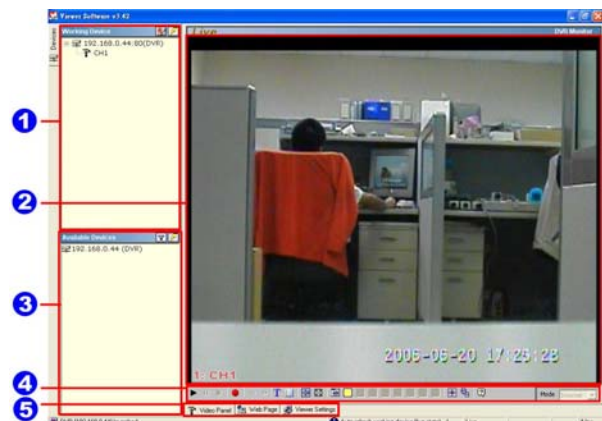

1 **【Working Device】** : After you enter the DVR, the section in the upper left margin will show the information in all the cameras.

2 **【Screen】** : The videos of the camera will show.

- 3 **【 Available Devices 】** : Here the whole DVR list is shown. You can connect with your selection. Double click any of them to open the screen below. Please enter the correct "Username" and "Password" to log into this DVR. The default "Username" and "Password" are "admin" and "9999" respectively.

- 4 **【 Function Key 】** : Click each of these buttons to execute its functions.



- 5 **【 Multiscreen Buttons 】** : You can interchange between three buttons here : the "Video Panel", "Web Page" and the "Viewer Settings" buttons.



5.2.3 Operation

5.2.3.1 Remote Control

- ✘ **Step 1:** After entering the "Viewer Software", please click the button to select "1 Channels DVR (Enhanced)" and then click the "Available Devices" button. The software will automatically search the whole local LAN 1-channel DVR device to see a list.



NOTE: If you want to create a new DVR, please press the button to add it.

- ✘ **Step 2:** Double click your selected device to see a window as on the right. Enter the "Username" and "Password" -- the default name and password are "admin" and "9999".

- ✘ **Step 3:** The default multi-screen is the 1-channel mode you see now.

- ✘ **Step 4 :** The Viewer Software helps you see any display mode you want.

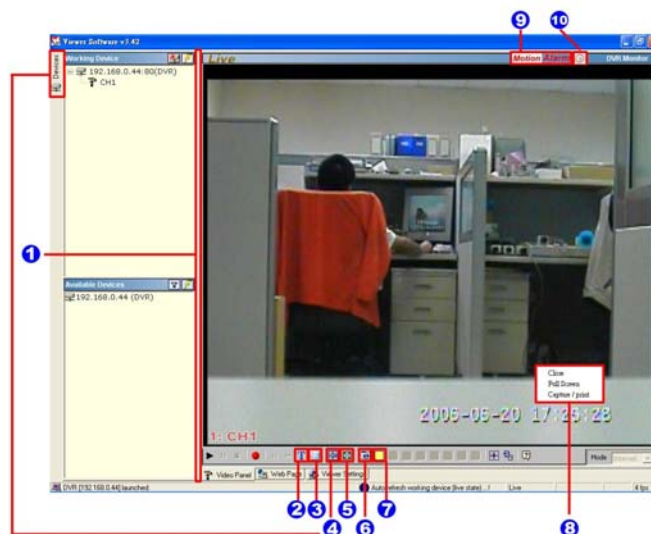

- 1. Adjust the screen size:** Move the mouse to the vertical bar on the right side of the "Work Devices" / "Available Devices" box on the left margin of the screen. This bar runs from the top to the bottom of the screen, and when you move the mouse to this bar, it shows like this: . You can move this bar to the left to narrow the "Working Devices" / "Available Devices" box and to the right to widen it.
- 2. Text Insertion Mode:** enable / disable.
Note: If the connected DVR has incoming text data, that data will be shown in the corresponding area for each channel at the same time. Please remember to turn on the RECORD/ TEXT INSERTION setting in the DVR setup menu.
- 3. Text Insertion Setting:** To set the phrase/exception for the DVR, please click this button option in the lower corner. The following is the phrase setting page.

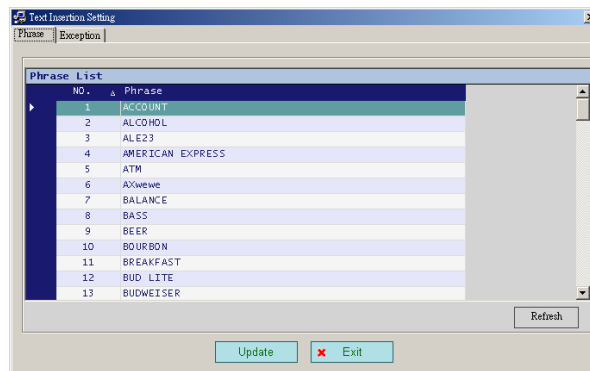

For the exception setting, please click the **"Exception List"** next to the **"Phrase List"**. Then input the exception strings and exception count for remote alter triggering. Click the **"Refresh"** button to submit the settings. The DVR will send the viewer software an alert when the exception has reached a particular count.

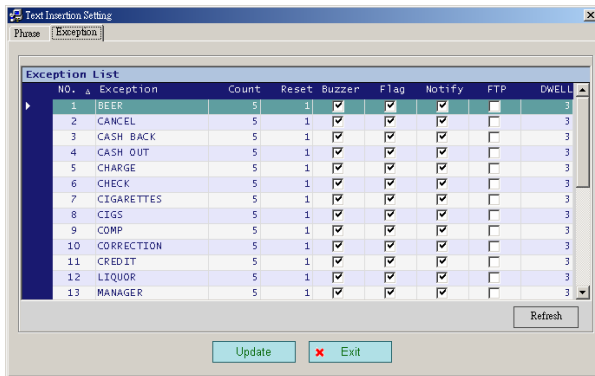

The alert window will show in the lower right corner. The following is the alert window page.



4. **Hide Device Panel:** Click this button to hide the **"Available Devices / Working Devices"** box from view behind the video display screen.
5. **Full Screen:** Click this button to show the full screen for surveillance. All the setting buttons will be hidden in this mode. If you want to return to the previous mode, use the mouse to click the right key, and choose **"Close"**.
6. **Re-arrange the divisions:** Click this button to see the following channels.
7. **Screen divisions:** Choose any of the buttons you want.
8. **Pop-menu:** You can use the mouse to move to each channel. Click the right key of the mouse to show a window. You can select **"Close"**, **"Full Screen"**, or **"Capture / Print"**.

- ※ **Close:** Stops the channel's display.
- ※ **Full Screen:** Enlarges the display to **"Full Screen"**.

※ **Capture / Print:**
"Capture":

See the **"Image Preview"** page for the **"Preview Setting"** which has two choices : **"Mark Date and Time"** and **"Dimension"**. Mark the item **"Mark Date and Time"** to set the date and time stamp on a chosen picture. Choose an appropriate dimension before saving the image. To save the image, click **"Save"** at the bottom to enter the **"Save Page"** window. Give the file name. If you want to exit, click **"Cancel"**.



"Print": Click the **"Print Preview"** button and go to the **"Preview"** option to adjust the image size. Go to the **"Print Settings"** area and then go to **"Mark Date and Time"** if you wish to stamp the date and time of the image on the image itself. Select **"Dimension"** to scroll the **"Original Image Size"** from the drop - down list. Click **"Print"** to start the printing. Click **"Cancel"** to exit.

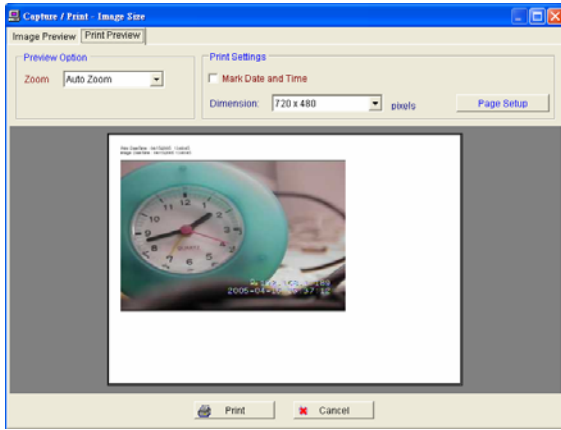

9. Motion / Alarm: The warning icons.

Motion icon: When there is a detection of motion in any channel, it will display this icon on the right upper corner on that channel to warn the user.

Alarm icon: When there is a detection of external devices such as a sensor, it will display this icon on the right upper corner on that channel to warn the user.

10. Remind the condition of recording:



When the user start to record, it will show this icon on the screen, and it will disappear when stop the recording.

5.2.3.2 Remote play and PTZ control.

This device has the full triplex so you can use the Viewer Software in the remote without affecting the performance of the 1-channel DVR. You can also use the Viewer Software to play and back up. If you have a PTZ camera, the Viewer Software can also control it.

5.2.3.2.1 Remote play



Play: Click it to see the DVR play window. Use the **"Previous page"** and **"Next page"** buttons to find the record you want from the record list. Click the **"Time Search"** page to use the time and date search entries to help your search. Click the **"Review Text"** page to use the text search. The search conditions include:

- . Channel
- . String
- . Date/Time
- . Amount

The user can input any combination of the above

conditions for searching. After a search, the Viewer software will list the data that meets the search conditions. Now the user can page up and down among that data. The user can also click that data record to start playback.

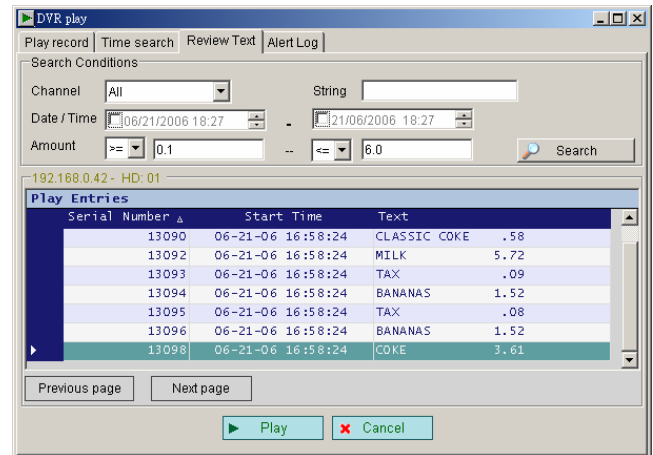

Please directly click the **"Search"** button for the FULL LIST, or enter the proper conditions in the Channel, String, Date/ Time and Amount fields for searching.

The search results will be shown in the list. To playback from the list, please select one of the items on the list, and then click the **"Play"** button.

For the **"Alert Log"**, please click the **"Alert Log"** next to the **"Review Text"**.

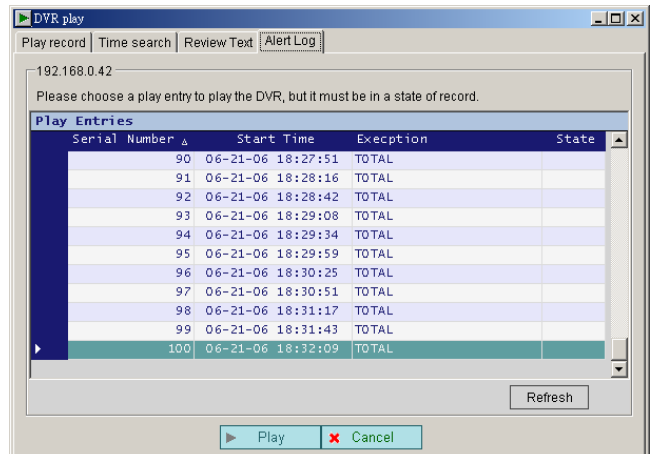

DVR keep up to 100 records of Alert log for viewing and playback. The records marked as **"REC"** means it can be click to start playback.

Pause: Click to freeze the image.

Stop: Click to stop playing back the recorded video.

REC: Click to control the recording of the DVR. Press the button to start or stop the recording.

REV: Click to play a recorded video in the reverse direction at speeds, which are faster

than the recorded speed.

▶▶ **"FWD"**: Click to play a recorded video in the forward direction at speeds, which are faster than the recorded speed.

5.2.3.2.2 Change Pan/Tilt/Zoom Setting

Click the  button on the home page to open the Speed Dome Controller.





1. Click the  button to control the Zoom setting on the Speed Dome Controller.

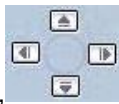

2. The right-hand set, , has four buttons, each of which, upon being clicked, will turn the camera all the way, without stopping, in one of the four designated directions. The fifth button, in the center, will stop the camera at any point you prefer.

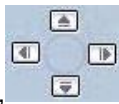

The left-hand set of buttons, , has four buttons, each of which, upon being clicked, will move one short step only in any of the four designated directions.

3. Select a Speed Dome device Model  from the drop-down list on the Speed Dome Controller. The Controller will be able to display the listed Models by turn.

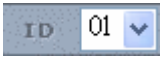
4. Select a Speed Dome device ID  from the drop-down list on the Speed Dome Controller. The Controller will

be able to display the listed IDs by turn.

5.





Each of the ten buttons under 'Set' is connected with a specific position and angle of either panning or tilting of the camera. Click each button to activate its particular position and angle. Press the button under 'Preset' to turn the camera angle by angle in the set positions.

Each of the ten buttons under 'Clear' can be clicked to delete the corresponding 'Set' button above it. For example, if you wish to de-activate 'Set' button #4, please click 'Clear' button #4 to delete its corresponding 'Set' counterpart.

Each of the ten buttons designated 'Go to' can be clicked to view the particular corresponding angle of the position in which it is set.

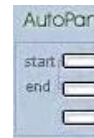
6.



The 'AutoPan' section  has three buttons. The 'Start' and 'End' buttons fix the two points of any panning movement you select. The third or bottom button sets the chosen movement in the play mode.

5.2.3.3 Backup and video edit

Use the  button to see the "Backup" window.

【Backup up to AVI】:

Backup Settings :

- **File Path** : To set the backup file path and the file name, click the "Browser" button on the right.
- **Frame Rate** : Sets the backup record file speed.
- **Maximum File Size** : Sets the maximum file size.
- **Frame dimension** : Sets the resolution.
- **Mark Day and Time** : Sets the date and time stamp.

Play Options :

- **Time to play**: To search the date and time you want.
- **Channel ID**: To choose the camera.

Play Monitor :

- Use the panel below to play or stop, etc.



- If you already want to back up, click the "Start backup" button. If you want to stop, click the "Stop backup" button.

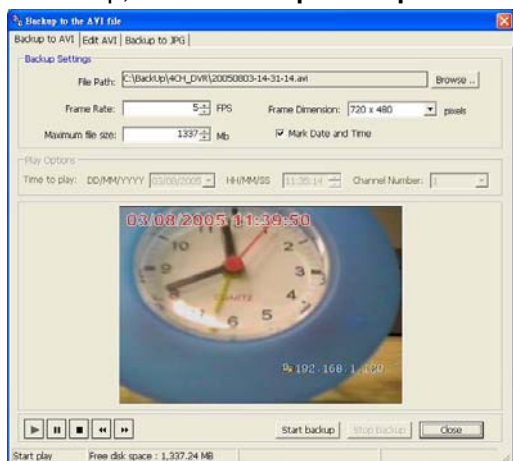

【Edit AVI】:

- **File Path**: To set the backup file and the file name, check the "Browser" button on the right. Click "Edit Selected File"

to start editing.

- **Frame Rate Modification**: To see the total number of frames, modify your frame rate.
- **File Preview**: Click the "Start" button to start your setting component. You can also use the "Start" button to interrupt the code. You can click the "Save to new file" button to save a new file after the edit code.

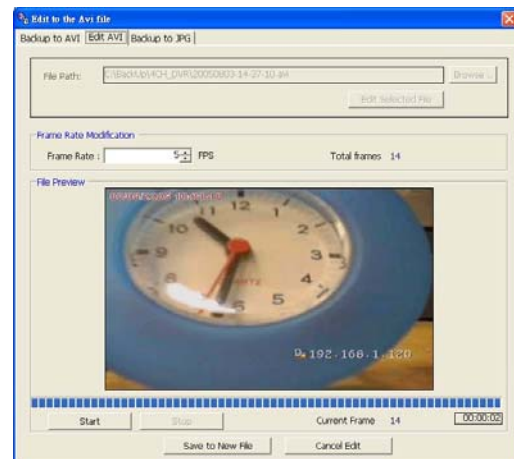

【Backup to JPG】:

- **Folder Path**: To set the backup file path, click the "Browser" button on the right.
- **Maximum Frames**: Sets the maximum amount of the frames which to backup.
- **Frame Dimension** : Sets the resolution.
- **Mark Day and Time** : Sets the date and time stamp.

Play Options :

- **Time to play**: To search the date and time you want.
- **Channel Number**: To choose the camera.

Play Monitor :

- Use the panel below to play or stop, etc.



If you already want to back up, click the "Start backup" button. If you want to stop, click the "Stop backup" button.

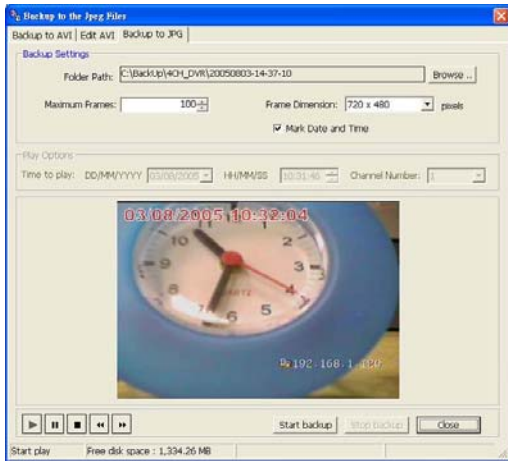

5.2.3.4 Web Page Viewer

This section provides instructions for using the Viewer Software to view the Web Page.

NOTE: This device also provides the IE Browser function. Open the browser and view the images directly via the browser. Please refer to section 5.3 for more details.

5.2.3.5 Viewer setting

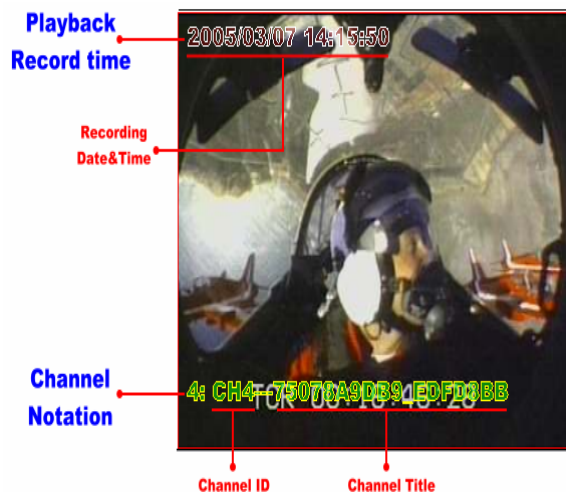
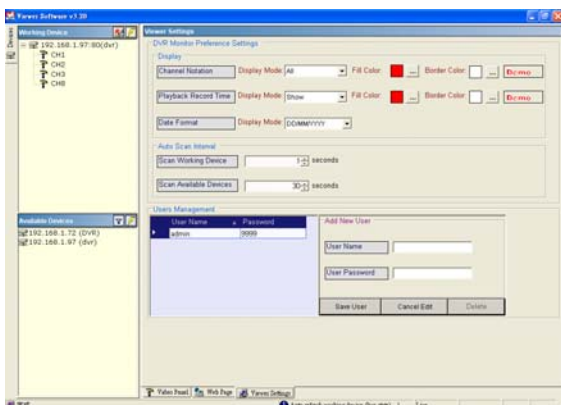

1. "Channel Notation".

If you wish to change the **"Display Mode"**, open its drop-down list and select any of the four items there. Your choice will automatically appear in the relevant blank space. Similarly you can enter the **"Fill Color"** and **"Border Color"** entries to open their respective color tables. Click **"OK"** in each case to set your choice.

2. "Playback Record Time".

Click the **"Display Mode"** to select from a drop - down list of two choices, **"Hide"** and **"Show"**. Your choice will decide whether the images will display their date and time or not.

3. "Auto Scan Interval".

Here you have two entries, **"Scan Working Devices"** and **"Scan Available Devices"**. Set the time in seconds for both entries as per your requirements. The **"Scan Working Devices"** entry has a time span of 1 to 5 seconds only. The **"Scan Available Devices"** time range covers 30 to 1000 seconds.

4. "Users Management".

Click the **"Save User"** button to add the new user's name and password under **"Add New User"**: Enter the **"User Name"** and **"Password"** and click **"Save User "** again. Your new user and his password will appear on the **"User Name & Password "** list to the left. If you proceed to enter a new user and then click **"Cancel Edit"**, no new name will be added to your list. If you wish to delete any user, click his name and click **"Delete"** to effect the change.

5.3 Microsoft Internet Explorer

This section provides instructions for using the Microsoft Internet Explorer.

5.3.1 Connecting the DVR

Start up the Microsoft Internet Explorer, and then follow the steps given below to connect the DVR:

1. Type in the URL address of the DVR into the URL block and press the “**Enter**” button to enter the login page. The default User Name and password are **admin** and **9999** respectively.
2. Enter the **User name** and **Password**.
3. Click the “**Login**” button and enter the home page of the DVR: both the user name and password must be provided correctly.

Browsing images from the DVR

The images from the DVR will be displayed on the home page while going online with the DVR. There are some buttons provided on the bottom of the home page for further setting.

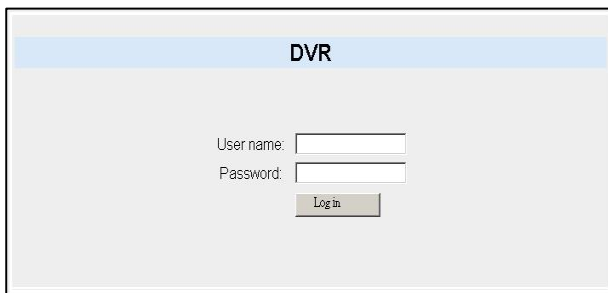

| Option Buttons | Description |
|----------------|---|
| | Click to stop playing back the recorded video. |
| | Click to a recorded video from the PLAY LIST. |
| | Click to freeze the image. |
| | Click to activate or stop the recording function of the device. |
| | Click to leave the home page of the DVR. |
| | Press to enter the SETUP window, and open the device setting page in order to add more devices for viewing. This allows you to program the Record Setting and Record Schedule. |
| | Press to enter the IMAGE window and open the device home page for viewing. |
| | Click to open the control panel and remote-control the pan/tilt/zoom function of a live camera within a local network or the Internet. |
| | Recorded video list box. This box allows you to access all recorded video, which are stored in the HDD of the connected devices. To review a recorded video, simply select an entry from the list and click the button. PgUp/PgDn: Enables you to scroll up and down the list. |

Time & Status Box. This box [LIVE] 10-30-2003 indicates the device status.

This allows you to search a recorded video stored under the “Date” entry of the device. Enter the YEAR/ MONTH/DAY HOUR: MINUTE you wish to search and click the GO button to proceed.

5.3.2 Change Record / Alarm Setting

Please follow the steps given below to change the Record / Alarm setting through the network as and when necessary.

1. Click the  button on the home page to enter the Record / Alarm setting page.

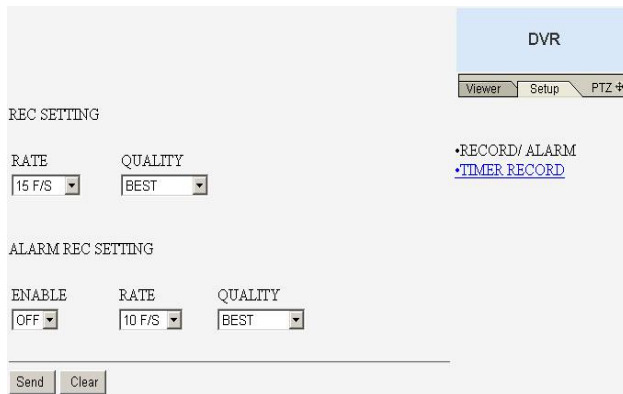

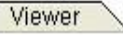

2. Adjust the Record / Alarm setting, including “REC rate”, “REC quality”, “ALARM REC enable”, “ALARM REC rate”, and “ALARM REC quality” as and when necessary.
3. Click the  button to submit the new Record / Alarm setting.
4. Click the  button to return to the home page while the new image setting acts on the images to effect the desired changes instantly. (If the setting has not been changed by the above steps, any (re)entry to the home page will find images in their earlier or original setting.)

5.3.3 Change Timer Record Setting

1. Click the  button on the home page to enter the Record / Alarm setting page.
2. Click the [•TIMER RECORD](#) connection on the

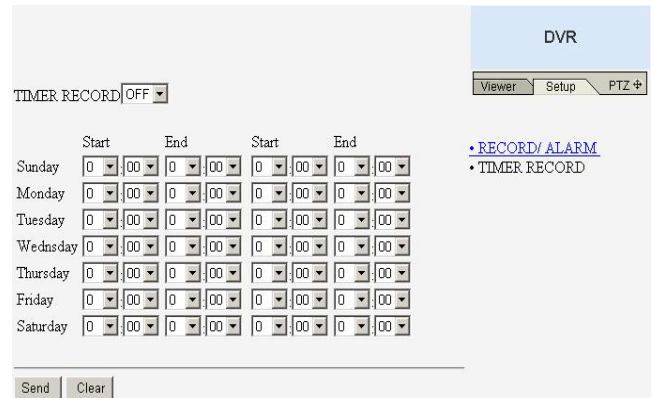
Record / Alarm setting page to enter the Timer Record setting page.

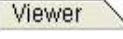

3. Set the **TIMER RECORD** to **ON** to enable the TIMER RECORD function.
4. There are two time-periods available for scheduling each day. The Timer Record setting page allows users to program the time each day that the DVR will start and stop recording. The time is displayed in a 24-hour clock format. If there is a time overlap showing between two continual time-period settings, the device will automatically combine the two time-period settings into one combined time-period setting.
5. Click the  button to submit the new Timer Record setting.
6. Click the  button to return to the home page while the new image setting acts on the images to effect the desired changes instantly. (If the setting has not been changed by the above steps, any (re)entry to the home page will find images in their earlier or original setting.)

5.3.4 Pan / Tilt / Zoom Setting

Click the **PTZ** button on the main page to open the Speed Dome Controller page. Then select a proper Speed Dome model on the left hand side. The function varies for different Speed Dome models. Here is an example.

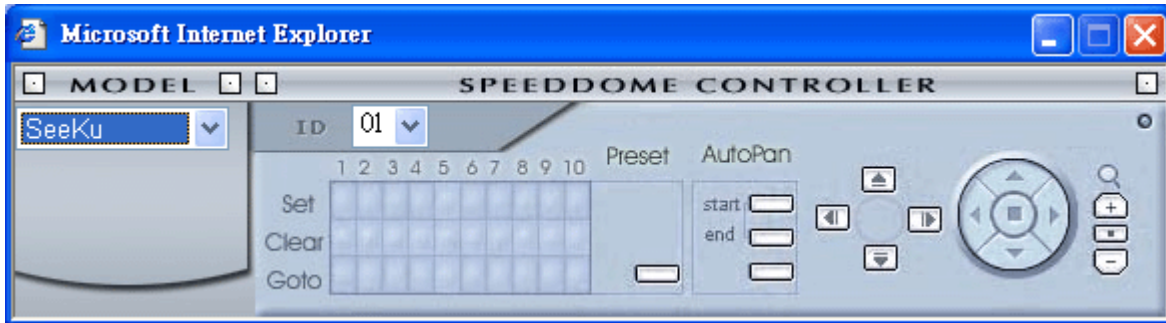

- Click the  button to control the Zoom setting on the Speed Dome Controller.



- The right-hand set, , has four buttons, each of which, upon being clicked, will turn the camera all the way, without stopping, in one of the four designated directions. The fifth button, in the center, will stop the camera at any point you prefer.

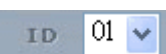

- The left-hand set of buttons, , has four buttons, each of which, upon being clicked, will move one short step only in any of the four designated directions.

-  Select a Speed Dome device ID from the drop-down list on the Speed Dome Controller. The Controller will be able to display the ID entries by turn.

11.



Each of the ten buttons under 'Set' is connected with a specific position and angle of either panning or tilting of the camera. Click each button to activate its particular position and angle. Press the button under "Preset" to turn the camera angle by angle in the set positions.

Each of the ten buttons on the "Clear" row can be clicked to delete the corresponding "Set" button above it. For example, if you wish to de-activate 'Set' button #4, please click 'Clear' button #4 to delete its corresponding 'Set' counterpart.

Each of the ten buttons designated 'Go to' can be clicked to view the particular corresponding angle of the position in which it is set.

12.

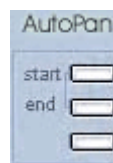

The 'AutoPan' section has three buttons. The 'Start' and 'End' buttons fix the two points of any panning movement you select. The third or bottom button sets the chosen movement in the play mode.

6. TEXT INSERTION FUNCTION

6. TEXT INSERTION FUNCTION

1. Purpose

The purpose of the Text Insertion function is to make the DVR accept the text information coming from external devices like ATM machines, cash registers, and access control systems. The DVR stores the text information in the hard disk, and shows the information on the screen during a video playback. Through various interfaces for text review, the user can search for and playback a desired video.

The main functions include:

1. DISPLAY – Desired text information will be shown on the screen in the playback mode.
2. Various TEXT REVIEW interfaces, including:
 - FULL LIST – Lists all the recorded text information page by page for selection.
 - BY STRING – Searches all the text information including the desired strings.
 - BY DATE/TIME - Lists some of the records with the text information within a desired period.
 - BY AMOUNT - Lists some of the records with the text information whose cash amount meets the desired range.
 - BY COMBINATION – Combines the above search interfaces on one and the same page.
3. Various EXCEPTION ALERT monitoring functions, including:
 - ALERT: A Trigger Alert signal after a specific number of exceptions. The number of exceptions and the reset time for the alert can be configurable.
 - BUZZER: The DVR Buzzer sound for exceptions.
 - FLAG: The DVR OSD flag display for exceptions.
 - NOTIFY: Notifies the remote viewer software after an ALERT has been generated.
 - FTP: Transfers images to an FTP server after an ALERT.

2. Specifications.

2.1 Hardware connection.

Connect the DVR and the text device through the RS-232 Null Modem Cable (Pin 2, Pin3 Cross over , Pin5 Ground).

TEXT INSERTION FUNCTION (continued)

2.2 RS-232 baud rate setting.

Baud rates can be set in the DVR, the baud rate selections including 2400, 4800, 9600, 19200, 28800, 38400, 57600 and 115200.

2.3 The maximum number of text information records.

For every 10.24 Giga bytes of hard disk capacity, the DVR reserves space for 32768 text records. Each hard disk keeps its own data in itself. In a DVR with two hard disks, the user can remove any one of them, and the remaining one will keep working.

For example, in the case of an 80G hard disk, the maximum number of recorded text information is $(80 / 10.24) \times 32768 = 196608$.

2.4 Data size.

Each text information contains up to 100 characters.

2.5 PROTOCOL.

The DVR supports the following two protocols; please set the appropriate one in the Setup Menu.

2.5.1 GENERIC.

All the text data is delimited by CR (Carriage Return = 0x0d) and LF(Line Feed = 0x0a).

2.5.2 VSI-ADD.

The text data includes CHANNEL information for application in the multi-channel environment as follows:

0x1b, <CH>, <TEXT> , 0x0d.

3. Operation

3.1 Settings.

3.1.1 Text Insertion Protocol.

SETUP / RECORD / TEXT INSERTION.

Set one of the following:

GENERIC:

Text format : <TEXT >+ CR(0x0d) + LF (0x0a)

VSI-ADD:

Text format: 0x1b + Ch + <TEXT> + CR(0x0d)

Note: The Text Insertion activates both the text data and the channel information in a DVR, and the remote viewer software takes effect after this option has been turned on.

3.1.2 RS232 Baud Rate.

SETUP / COMMUNICATION / BAUD

Set at the same speed as that in the Text Input device.

3.1.3 Firmware version and capacity usage.

SETUP / SYSTEM / VERSION.

```
MAC : 00:0C:0C:00:00:10
BIOS : 1.00
SW  : 1.11GBT
DATE: Feb 24 2006

TEXT# : 186/ 65536

PRESS ENTER TO RETURN
```

The 2 numbers after “TEXT # :” are the current index number of the TEXT data and the total number of TEXT data.

3.1.4 Text color setting.

There are 8 options (BLUE, ORANGE, RED, MAGENTA, GRAY, WHITE, YELLOW, GREEN); If the **TEXT INSERTION** option has been set as **VSI-ADD** protocol, and incoming texts come from different channels, all the messages of the channels could be set in different colors are shown as below.

```
TEXT INSERTION
TEXT INSERTION      : OFF
TEXT COLOR          : SET
TEXT DISPLAY        : BY CHANNEL
PHRASE              : #1..10
EXCEPTION           : #1..10

MAIN PAGE
TEXT COLOR
```

```
TEXT COLOR
CH1  ■ WHITE
CH2  ■ YELLOW
CH3  ■ GREEN
CH4  ■ BLUE
```

3.1.5 Text display setting.

There are 2 options (BY CHANNEL, MIXED); If the **TEXT INSERTION** option has been set as **VSI-ADD** protocol, and incoming texts come from different channels, all the messages of the channels could be set in different channels.

By channel: This mode shows a 4-channel screen where each channel displays information text against a background of images -- both the text and the images belong to that channel only.

Mixed: This mode shows a 4-channel screen where each channel shows its own images only; but the entire screen shows information text overlapping across all the channels. The data for all the channels will show as it comes in, without following any channel sequence by numerical order.

| TEXT INSERTION | |
|------------------------------------|--------------|
| TEXT INSERTION | : OFF |
| TEXT COLOR | : SET |
| TEXT DISPLAY | : BY CHANNEL |
| PHRASE | : #1..10 |
| EXCEPTION | : #1..10 |
| <input type="checkbox"/> MAIN PAGE | |
| TEXT DISPLAY | |

| TEXT INSERTION | |
|------------------------------------|------------|
| TEXT INSERTION | |
| TEXT COLOR | |
| TEXT DISPLAY | BY CHANNEL |
| PHRASE | MIXED |
| EXCEPTION | |
| <input type="checkbox"/> MAIN PAGE | |
| TEXT DISPLAY | |

3.1.6 Phrase setting.

The 100 built-in phrases enable the user to input the strings more quickly. Since users need to change the characters one by one when they input the string value in the search menu or search menu, the phrase offers another shortcut to input the common strings.

Enter SETUP/ RECORD/ TEXT INSERTION/ PHRASE

There are 11 options (1..10,11..20,.... 99..100," FACTORY DEFAULT"); please select one, and then enter the inner page for the string settings. The last one, "FACTORY DEFAULT", is used to go back to the default values.

| TEXT INSERTION | |
|------------------------------------|----------|
| TEXT INSERTION | |
| TEXT COLOR | |
| TEXT DISPLAY | # 1..10 |
| PHRASE | #11..20 |
| EXCEPTION | #21..30 |
| | #31..40 |
| | #41..50 |
| | #51..60 |
| | #61..70 |
| | #71..80 |
| | #81..90 |
| | #91..100 |
| <input type="checkbox"/> MAIN PAGE | |
| # 1..10 | |

| TEXT INSERTION | |
|------------------------------------|-----------------|
| TEXT INSERTION | |
| TEXT COLOR | |
| TEXT DISPLAY | #11..20 |
| PHRASE | #21..30 |
| EXCEPTION | #31..40 |
| | #41..50 |
| | #51..60 |
| | #61..70 |
| | #71..80 |
| | #81..90 |
| | #91..100 |
| | FACTORY DEFAULT |
| <input type="checkbox"/> MAIN PAGE | |
| FACTORY DEFAULT | |

```

PHRASE # 1..10

1 [ACCOUNT ]
2 [ALCOHOL ]
3 [ALE ]
4 [AMERICAN EXPRESS ]
5 [ATM ]
6 [AX ]
7 [BALANCE ]
8 [BASS ]
9 [BEER ]
10 [BOURBON ]

```

While the users input string data in the setup menu or search menu, they can also press the **SETUP** button to quickly acquire the required or relevant phrases; please see the following examples.

```

BY STRING

CHANNEL ALL

TEXT [ ]

03-20-2006 13:36:08

```

```

CHANNEL ALL
TEXT [ ]

PHRASE PAGE 5
EXTRA
EXTRA LARGE
FISH
GAS
GASOLINE
GIN
GUINNESS
HEINKEN
INPORT
KEG

03-20-2006 13:36:08

```

```

EXCEPTION # 1..10

1 [ALE ] [00]
2 [CAN ] [00]
3 [CAS ] [00]
4 [CAS ] [00]
5 [CHA ] [00]
6 [CHE ] [00]
7 [CIG ] [00]
8 [CIG ] [00]
9 [COM ] [00]
10 [COR ] [00]

PHRASE PAGE 5
EXTRA
EXTRA LARGE
FISH
GAS
GASOLINE
GIN
GUINNESS
HEINKEN
INPORT
KEG

```

3.1.7 Exception setting.

Enter SETUP/ RECORD/ TEXT INSERTION/ EXCEPTION

The purpose of using the exceptions is to filter some special string and alter the remote users. There are 4 options (1 ..10, 11..20, 21..25, "FACTORY DEFAULT"); please select one, and then enter the inner page for the string settings. The last one, "FACTORY DEFAULT", is used to go back to the default values.

In the right-hand side of the Exception Setting page is the exception count. If a number has been specified, the DVR will alert the remote Viewer Software when the number of the exceptions exceeds the number set here.

TEXT INSERTION

TEXT INSERTION
TEXT COLOR
TEXT DISPLAY
PHRASE
EXCEPTION _____ **# 1..10**
#11..20
#21..25
FACTORY DEFAULT

MAIN PAGE

1..10

EXCEPTION # 1..10

| | | |
|----|-------------|---|
| 1 | [BEER |] |
| 2 | [CANCEL |] |
| 3 | [CASH BACK |] |
| 4 | [CASH OUT |] |
| 5 | [CHARGE |] |
| 6 | [CHECK |] |
| 7 | [CIGARETTES |] |
| 8 | [CIGS |] |
| 9 | [COMP |] |
| 10 | [CORRECTION |] |

NEXT PAGE

3.1.8 EXCEPTION PARAMETER.

In the EXCEPTION setting page, press the SEARCH button to enter the EXCEPTION PARAMETER setting page. In the PARAMETER EXCEPTION setting page, press the SEARCH button to return to the EXCEPTION setting page.

For each EXCEPTION, the user can set the following parameters.

3.1.8.1 CNT (Count) 0..99

When the number of exceptions exceeds this number, the DVR will generate an ALERT event. If this number is set as 0, any exception will be ignored.

3.1.8.2 RST (Reset Time) 0..24

If no exception has been detected for a certain number of hours, the Exception count (in 3.1.8.1) will be reset to 0.

3.1.8.3 BUZ (Buzzer) Off/ On.

If the BUZ has been set as ON, the DVR will generate a buzzer sound as a warning when an exception has been detected. The duration depends on the DWELL setting (3.1.8.7).

Note: The buzzer setting in SYSTEM/ BUZZER must also be set as ON, or the function will not take effect.

3.1.8.4 FLG (Flag).

If the FLG has been set as ON, the DVR will show a mark (*) on the screen, and keep flashing for a duration depending on the setting in DWELL(3.1.8.7).

3.1.8.5 NFY (Notify Remote).

If the NFY setting has been set as ON, the DVR will notify the remote viewer software when the ALERT event has been generated. At the same time, a message "ALT" will be shown on the screen.

3.1.8.6 FTP.

If the FTP setting has been set as ON, the DVR will start to send pictures to an FTP server after the ALERT event has been generated. The rate is fixed at 1f/ 1s, and the duration is 10 sec.

Note: The settings in the FTP SETTING must also be properly set, or the function will not take effect. The FTP SETTING/ FTP MODE item must be set especially as EXCEPTION.

3.1.8.7 DWE (DWELL).

The durations for the above BUZ (3.1.8.3) and FLG(3.1.8.4)functions are shown as below.

| EXCEPTION # 1..10 | | | | | | | |
|-------------------|-----|-----|-----|-----|-----|-----|-----|
| | CNT | RST | BUZ | FLG | NFY | FTP | DWE |
| 1 | 05 | 01 | ON | ON | ON | OFF | 03 |
| 2 | 05 | 01 | ON | ON | ON | OFF | 03 |
| 3 | 05 | 01 | ON | ON | ON | OFF | 03 |
| 4 | 05 | 01 | ON | ON | ON | OFF | 03 |
| 5 | 05 | 01 | ON | ON | ON | OFF | 03 |
| 6 | 05 | 01 | ON | ON | ON | OFF | 03 |
| 7 | 05 | 01 | ON | ON | ON | OFF | 03 |
| 8 | 05 | 01 | ON | ON | ON | OFF | 03 |
| 9 | 05 | 01 | ON | ON | ON | OFF | 03 |
| 10 | 05 | 01 | ON | ON | ON | OFF | 03 |

PREV PAGE

3.1.9 AMOUNT EXCEPTION.

In the EXCEPTION setting page, #25 is a special item for amount exception. When the amount exceeds this number, the DVR will generate an Exception event, too.

| EXCEPTION # 21..25 | |
|--------------------|--------------------------------|
| 21 | [RETURN] |
| 22 | [TOTAL] |
| 23 | [VOID] |
| 24 | [WINE] |
| 25 | AMOUNT >= 000000.00 (OR <= -N) |

NEXT PAGE

3.2 System Connection.

3.2.1 Single Device Connection.

When only one Text device (such as a cash register) is used, please set the setting in the Setup Menu according to 3.1.1.1.

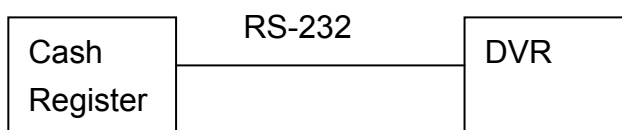

3.2.2 Multiple Devices Connection.

By using AVE REGCOM and HYDRA, a multiple cash register can be linked together through an RS-485, and can finally connect to the DVR through the RS-232.

The following is an example of 4 cash registers connected to a DVR.

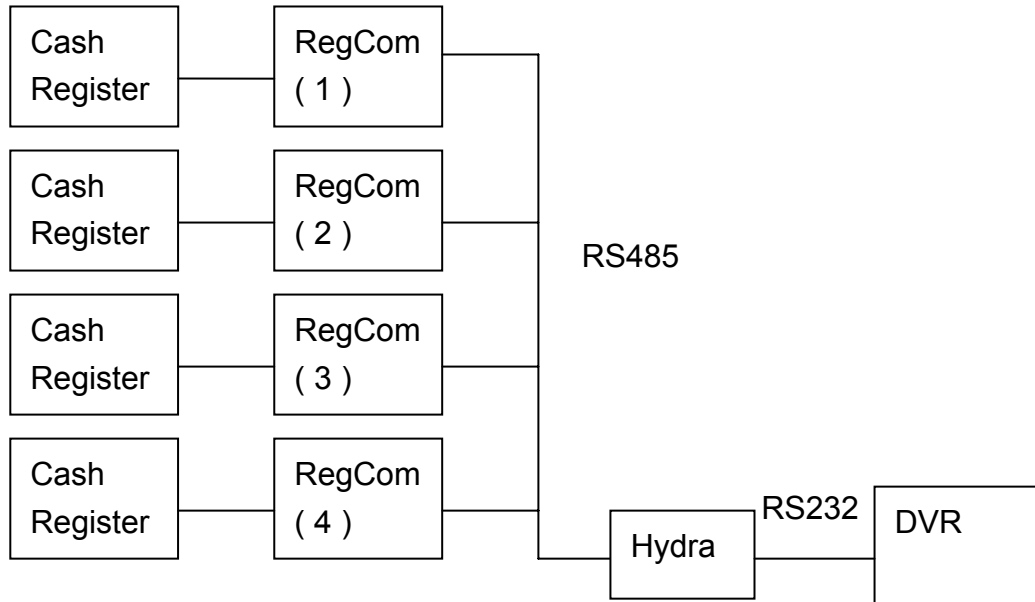

For proper setting, please refer to 3.1.1 section in this chapter.

3.2.3 LIVE DISPLAY.

After the hardware has been connected, please power up the DVR. The DVR is by default in the LIVE mode. Press the **DISPLAY** button to switch to different display modes; under any one of the following modes, the contents of the received text data will be shown on the screen.

3.2.3.1 Simple Text Display Mode.

An example:

On the left-lower corner, the OSD message "SM TOMATOS .48" is the newest incoming TEXT data.

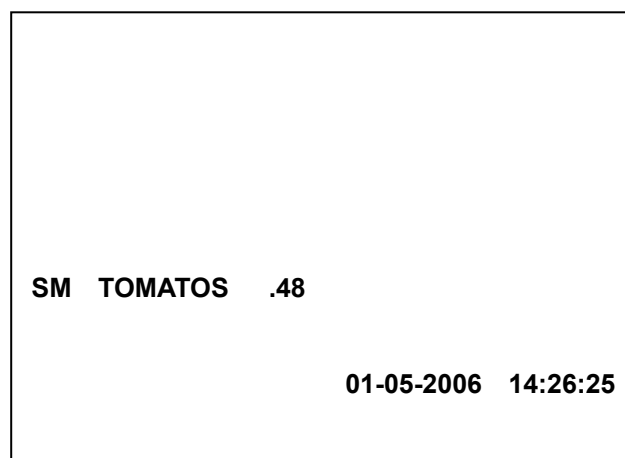

3.2.3.1 Full Text Display Mode.

All the incoming TEXT data are shown in the middle of the screen; the previous data is scrolled up when the latest one arrives.

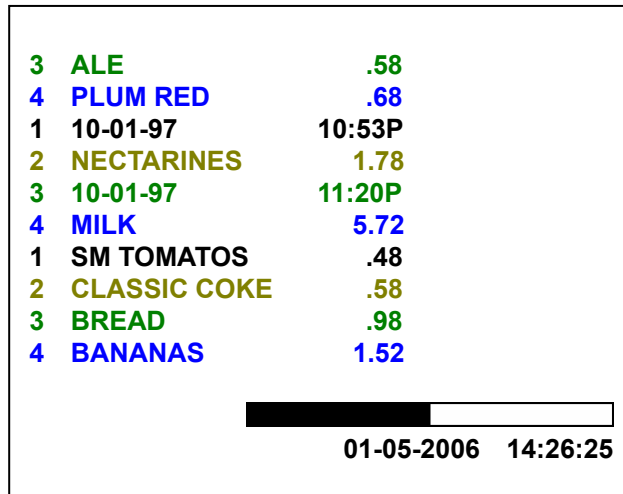

| | | |
|---|--------------|--------|
| 3 | ALE | .58 |
| 4 | PLUM RED | .68 |
| 1 | 10-01-97 | 10:53P |
| 2 | NECTARINES | 1.78 |
| 3 | 10-01-97 | 11:20P |
| 4 | MILK | 5.72 |
| 1 | SM TOMATOS | .48 |
| 2 | CLASSIC COKE | .58 |
| 3 | BREAD | .98 |
| 4 | BANANAS | 1.52 |

01-05-2006 14:26:25

If the TEXT INSERTION option has been set as **VSI-ADD**, and incoming texts come from different channels.

A percentage bar in the right-lower corner reveals the text data usage. For example, if the total number of text data is 65536 and the number of the current used text data is 32768, the bar will be shown about 50% full. For the precise number please refer to SETUP/ SYSTEM/VERSION in the local device OSD.

3.2.4 RECORDING

When the text data continuously inputs from the Text device, press the REC button to activate recording; while the DVR is in the RECORD mode, there is a small red ball periodically flashing in the right-upper corner of the screen. Please press the DISPLAY button to switch to a desired mode to observe the incoming TEXT data.

To stop recording, please press the REC button and hold for more than 3 seconds before releasing.

3.2.5 PLAYBACK.

Press the SEARCH button to enter the Search Menu, highlight a desired item in the list, and then press the ENTER button to start playback. During playback, the DISPLAY can also be used to switch to the display modes, to see the Text data that was received when the corresponding video was recorded. The Text data is shown even in the trick play mode, like fast forward and slow motion.

If the TEXT INSERTION option has been set as **VSI-ADD** and incoming texts come from different channels.

3.2.6 REVIEW TEXT.

Press the **SEARCH** button and hold for more than 3 seconds. The **REVIEW TEXT** mode will then be activated, with 6 items for selection.

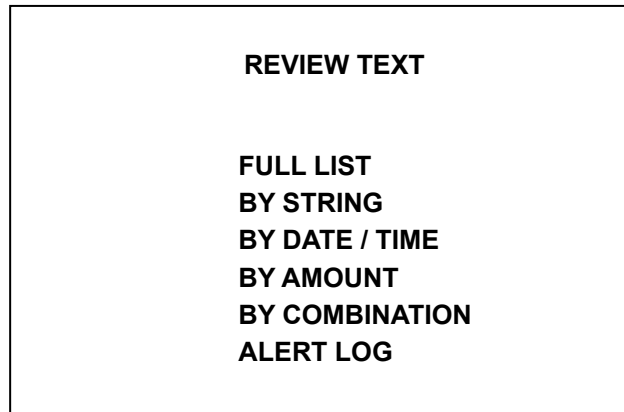

3.2.6.1 FULL LIST.

If the TEXT INSERTION in the Setup Menu is set as **GENERIC** (refer to 3.1.1 section in this chapter), the list is shown as below.

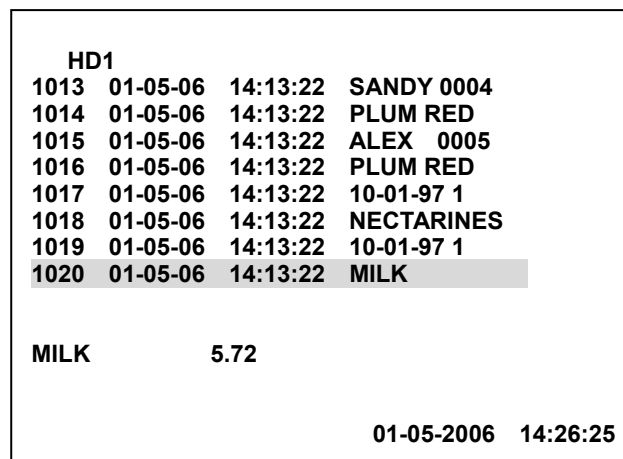

Alternately, if the TEXT INSERTION is set as **VSI-ADD**, the following channel selection screen will be shown first as the input of the desired channel. The selectable options are ALL, CH1, CH2, CH3 and CH4.

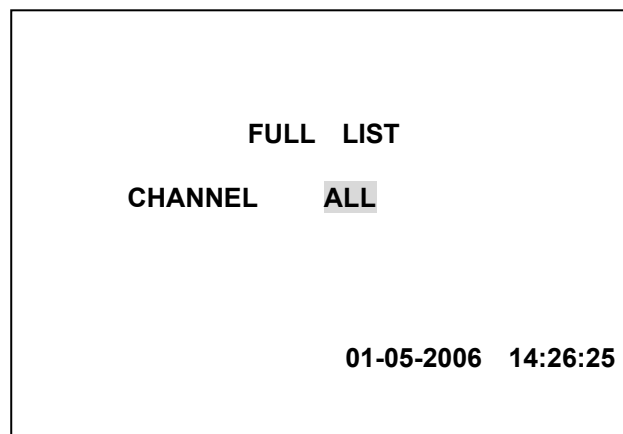

Once a channel is selected and the **ENTER** button is pressed, all the Text Data of the particular channel will be listed.

| HD1 | | | CH 1 2 3 4 | | | |
|---------------------|----------|----------|------------|--|--|--|
| 781 | 01-02-06 | 11:34:12 | CASH | | | |
| 782 | 01-02-06 | 11:34:12 | CHANGE | | | |
| 783 | 01-02-06 | 11:34:12 | ALEX 0005 | | | |
| 784 | 01-02-06 | 11:34:13 | PLUM RED | | | |
| 785 | 01-02-06 | 11:34:13 | 10-01-97 1 | | | |
| 786 | 01-02-06 | 11:34:13 | NECTARINES | | | |
| 787 | 01-02-06 | 11:34:13 | 10-01-97 1 | | | |
| 788 | 01-02-06 | 11:34:13 | SANDY 0004 | | | |
| | | | | | | |
| SANDY 0004 24536 | | | | | | |
| | | | | | | |
| 01-02-2006 18:59:25 | | | | | | |

3.2.6.2 BY STRING.

The "BY STRING" function offers an interface to search for some specific material. The text may include names of personnel, goods, cash totals and balances, and/ or other miscellaneous items. If you want to access the records of a particular goods, see the "TEXT" entry and type in its name. At once you may find classifications, appearing under the category of that particular goods if such classifications exist. If you enter "COKE", you'll see both "COKE" and "CLASSIC COKE" listed, for instance. You can highlight the one you want, and start to playback.

If the TEXT INSERTION is set as **GENERIC**, the "BY STRING" screen will have only a "TEXT" string as input. Up to 16 characters can be input for searching.

If the TEXT INSERTION is set as **VSI-ADD**, there is a channel item which will show on the screen, too.

| | |
|---------------------|------------|
| BY STRING | |
| CHANNEL | ALL |
| TEXT [|] |
| 01-02-2006 19:26:55 | |

To search for a two-word string, please enter the words with one space between the words, for example, "SANDY 0004"

```

BY STRING
CHANNEL ALL
TEXT [SANDY 0004 ]
01-02-2006 19:27:30

```

3.2.6.3 BY DATE/ TIME.

This function offers an interface to list the data within a specific time period. If the TEXT INSERTION is set as **GENERIC**, the "BY DATE/ TIME" screen will have starting DATE TIME items and ending DATE/TIME items as inputs.

If the TEXT INSERTION is set as **VSI-ADD**, there is a channel item which will be shown on the screen, too

```

BY DATE / TIME
CHANNEL CH1
MM DD YEAR HH MM -
01 / 02 / 2006 00 00
MM DD YEAR HH MM
01 / 02 / 2006 23 59
01-02-2006 19:29:02

```

3.2.6.4 BY AMOUNT.

This function offers an interface to search above and under a particular amount across the transactions recorded in the different channels.

If the TEXT INSERTION is set as **GENERIC**, the "BY AMOUNT" screen will have only 2 sets of entries each under "OPERATION" and " AMOUNT" as inputs.

The selectable operations are ">=", ">", "=", "<" and "<=".

If the TEXT INSERTION is set as **VSI-ADD**, there is a channel item which will show on the screen, too.

| BY AMOUNT | |
|---------------------|---------|
| CHANNEL | CH1 |
| OPERATION | AMOUNT |
| >= | 0000.00 |
| -- | 0000.00 |
| 01-02-2006 19:31:33 | |

The following are some examples for your operations.

A. To search Amount >= 1.00, the following items are shown on the screen.

>= 00001.00
-- 00000.00

B. To search Amount <= 1.00, , the following items will be shown on the screen.

<= 00001.00
-- 00000.00

C. To search Amount = 1.00 , the following items appear on the screen.

= 00001.00
-- 00000.00

D. To search 1.00 <= Amount <= 10.00, the following items will show on the screen.

>= 00001.00
<= 00010.00
or
<= 00010.00
>= 00001.00

E. To search Amount <= 1.00 OR Amount >= 10.00, the following items will be shown on the screen.

>= 00010.00
<= 00001.00
or
<= 00001.00
>= 00010.00

Note: If two operations are set and those two are exclusive of each other, the system will automatically add an "OR" between them. Otherwise, the system adds an "AND" between them.

3.2.6.5 BY COMBINATION

| BY COMBINATION | |
|---|-----|
| CHANNEL | ALL |
| STRING | SET |
| BEER | |
| DATE/ TIME | SET |
| 00/00/0000 00:00:00 - | |
| 00/00/0000 23:59:00 | |
| AMOUNT | SET |
| >= 0010.00 | |
| ◀▶ MOVE ▲▼ CHANGE <input type="checkbox"/> SEARCH | |

BY COMBINATION is the combination of the above search interfaces. The user can give the different conditions on the same page. The search procedure can be repeated between the BY COMBINATION page and the search result page (TEXT LIST).

If the TEXT INSERTION is set as **VSI-ADD**, there is a channel item which will show on the screen, too.

In this page, please use the < and > buttons to move between items, and use the ^ and v buttons to change the values. Once the value has been set to "SET", please press the **ENTER** button to enter the "BY STRING", " BY DATE/ TIME" and "BY AMOUNT" pages for further settings. For the operations in the lower level pages, please refer to section 3.2.6.2, 3.2.6.3 and 3.2.6.4 in this chapter. When you are in those lower level pages, press the **ENTER** button to go back to "BY COMBINATION". After all the conditions have been set properly, please press the SEARCH button to start searching. In the "TEXT LIST" page, please press the ENTER button to start playback, and press the **SEARCH** button to return to the "BY COMBINATION" page.

7. MISCELLANEOUS

7. MISCELLANEOUS

7.1 RS-232 & RS-485 Setup & Protocol

7.1.1 RS232 & RS485 Setup

Use a Null Modem cable (the standard RS-232 9 Pin Cable with Pin 2 and Pin 3 exchanged, see pin configuration chart below for details) to connect the COM 1 on the rear panel of the DVR to a PC.

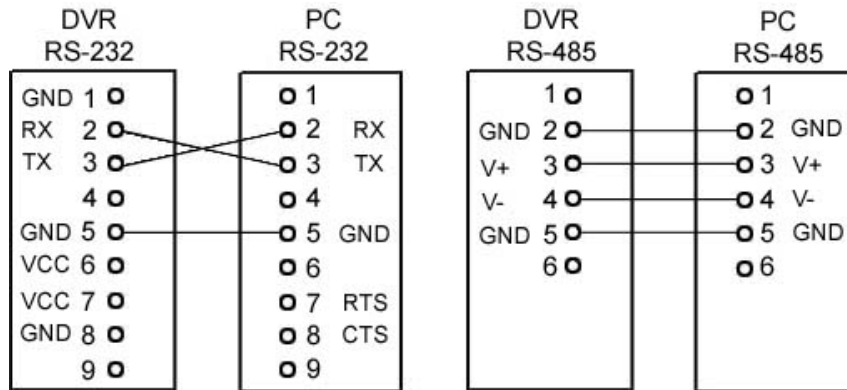

Set the **RS-232** option to **ON** in the **COMMUNICATION** page of the setup menu.

Set the PC communication parameters: 9600 bps, No Parity, 8 Data Bits, 1 Stop Bit.

7.1.2 Communication Protocol

7.1.2.0 General Command Format

<Lead Code = 0x41>, < Dest ID >, < Src ID >, <Main category >, <Second category >, {<Number of parameters>, <Parameter 1>, <Parameter 2> ...} <End Code= 0x4f>

Lead Code = 0x41
Dest ID = 0x01
Src ID = 0x20
Main Category = 0x01 Keys and Signals
= 0x02 Command
Second Category = 0x01 Handshake
= 0x02 Request Time/Set Time
= 0x06 Request System State
= 0x0b Time Search
= 0x10 Request HDD Info
= 0x11 Request REC Position
= 0x12 Playback Immediately
End Code= 0x4f

The different command types and their corresponding parameters are as follows:

MISCELLANEOUS (continued)

7.1.2.1 Keys and signals (Main Category = 0x01)

PC message: <0x41>, <0x01>, <0x20>, <0x01>, <Key Value>, <0x4f>

< The value of a specific front panel key >

| | DEC | HEX | |
|--------------------|-----|-------|-------------------|
| KEY_PLAY | 1 | 0x01 | |
| KEY_STOP | 3 | 0x 03 | |
| KEY_PAUSE | 4 | 0x 04 | |
| KEY_REC | 6 | 0x 06 | |
| KEY_SETUP | 7 | 0x 07 | |
| KEY_ENTER | 8 | 0x 08 | |
| KEY_SEARCH | 10 | 0x 0A | |
| KEY_DISPLAY | 11 | 0x 0B | |
| KEY_UP | 13 | 0x 0D | |
| KEY_DOWN | 14 | 0x 0E | |
| KEY_LEFT | 15 | 0x 0F | |
| KEY_RIGHT | 16 | 0x 10 | |
| KEY_MONITOR | 36 | 0x 24 | |
| JOG_L | 128 | 0x 80 | |
| JOG_R | 129 | 0x 81 | |
| KEY_SHUTTLE_L8 | 130 | 0x 82 | (-100x, -1/16x) |
| KEY_SHUTTLE_L7 | 131 | 0x 83 | (-100x, -1/16x) |
| KEY_SHUTTLE_L6 | 132 | 0x 84 | (-30x, -1/8x) |
| KEY_SHUTTLE_L5 | 133 | 0x 85 | (-16x, -1/8x) |
| KEY_SHUTTLE_L4 | 134 | 0x 86 | (-8x, -1/4x) |
| KEY_SHUTTLE_L3 | 135 | 0x 87 | (-4x, -1/4x) |
| KEY_SHUTTLE_L2 | 136 | 0x 88 | (-2x, -1/2x) |
| KEY_SHUTTLE_L1 | 137 | 0x 89 | (-1x, -1/2x) |
| KEY_SHUTTLE_CT | 138 | 0x 8A | |
| KEY_SHUTTLE_R1 | 139 | 0x 8B | (2x, 1/2x) |
| KEY_SHUTTLE_R2 | 140 | 0x 8C | (4x, 1/2x) |
| KEY_SHUTTLE_R3 | 141 | 0x 8D | (8x, 1/4x) |
| KEY_SHUTTLE_R4 | 142 | 0x 8E | (16x, 1/4x) |
| KEY_SHUTTLE_R5 | 143 | 0x 8F | (30x, 1/8x) |
| KEY_SHUTTLE_R6 | 144 | 0x 90 | (100x, 1/8x) |
| KEY_SHUTTLE_R7 | 145 | 0x 91 | (100x, 1/16x) |
| SIGNAL_REC_IN | 163 | 0x A3 | |
| SIGNAL_ALARM_RESET | 165 | 0x A5 | |
| SIGNAL_REC_OUT | 169 | 0x A9 | |
| SIGNAL_ALARM_IN | 189 | 0x BD | |
| SIGNAL_ALARM_OUT | 209 | 0x D1 | |

7.1.2.2 COMMAND (Main Category=0x02)

A. Handshake (Second Category=0x01)

PC request: <0x41>, <0x01>, <0x20>, <0x02>, <0x01>, <0x00>, <0x4f>

DVR Response: <0x41>, <0x20>, <0x01>, <0x02>, <0x08>, <0x00>, <0x4f>

B. Request Time (Second Category=0x02)

PC Request: <0x41>, <0x01>, <0x20>, <0x02>, <0x02>, <0x00>, <0x4f>

DVR Response: <0x41>, <0x20>, <0x01>, <0x02>, <0x02>, <0x07>, <7 Time Value >, <0x4f>

The following case is an illustration of < 7 Time Value>

2004/06/20 17:05:00 = <0xD4>, <0x07>, <0x06>, <0x14>, <0x11>, <0x05>, <0x00>

C. Set Time (Second Category=0x02)

PC Request: <0x41>, <0x01>, <0x20>, <0x02>, <0x02>, <0x07>, <7 Time Value >, <0x4f>

The following case is an illustration of < 7 Time Value>

2004/06/20 17:05:00 = <0xD4>, <0x07>, <0x06>, <0x14>, <0x11>, <0x05>, <0x00>

DVR Act: Changing the time and date.

D. Request State (Second Category=0x06)

PC Request: <0x41>, <0x01>, <0x20>, <0x02>, <0x06>, <0x00>, <0x4f>

DVR Response: <0x41>, <0x20>, <0x01>, <0x02>, <0x06>, <0x01>, <System State = 0.>, <0x4f>

Description of <System State>:

| | |
|--------------|----|
| STATE_STOP | 0 |
| STATE_PLAY | 3 |
| STATE_SETUP | 6 |
| STATE_SEARCH | 7 |
| STATE_BACKUP | 15 |

E. Time Search (Second Category=0x0b)

PC message: <0x41>, <0x01>, <0x20>, <0x02>, <0x0b>, <0x06>, <6 Bytes Date/Time>, <0x4f> where < 6 bytes Date/Time >, = year (2 bytes, =LowByte + HighByte*256), month (1 byte), day (1 byte), hour (1 byte), min (1 byte)

Example: to search 06/12/2004 17:00 the Date/Time = <0xd4>, <0x07>, <0x06>, <0x0c>, <0x11>, <0x00> where 2004= 212(=0xd4) + 7(=0x07) *256

F. Request HDD Info (Second Category=0x10)

PC message: <0x41>, <0x01>, <0x20>, <0x02>, <0x10>, <0x00>, <0x4f>

DVR Response: <0x41>, <0x20>, <0x01>, <0x02>, <0x10>, <0x32>, <0x00>, <0x00>, <48 Bytes Data> <0x4f>

<48 Bytes Data>=4 HDD Status(Primary Master/Slave, Secondary Master/Slave)

Every HDD use 12 Bytes=

#0 :HDD Exist (if = 1)

- #1 :Active HDD (if = 1)
- #2 :Current HDD for REC (if = 1)
- #3 :Current HDD for PLAY (if = 1)
- #4...#7 :Capacity
- #8.. #11 :REC/PLAY Position

G. Request REC Position (Second Category=0x11)

PC message: <0x41>, <0x01>, <0x20>, <0x02>, <0x11>, <0x00>, <0x4f>

REC Mode

DVR Response: <0x41>, <0x20>, <0x01>, <0x02>, <0x11>, <0x08>, <HDD#>, <0x0>, <4 Bytes REC Position>, <2 Bytes Image NO.>, <0x4f>

Get HDD#, REC Position and Image NO. used in **Playback Immediately** command

Non REC Mode

DVR Response ERROR: <0x41>, <0x20>, <0x01>, <0x02>, <0x11>, <0x01>, <0x45>, <0x4f>

H. Playback Immediately (Second Category=0x12)

PC message: <0x41>, <0x01>, <0x20>, <0x02>, <0x12>, <0x0a>, <HDD#>, <0x0>, <0x0>, <0x0>, <4 Bytes REC Position>, <2 Bytes Image NO.>, <0x4f>

On Success

DVR Response: <0x41>, <0x20>, <0x01>, <0x02>, <0x12>, <0x00>, <0x4f>

On Error

DVR Response ERROR: <0x41>, <0x20>, <0x01>, <0x02>, <0x12>, <0x01>, <0x45>, <0x4f>

7.2 Hard Disk Installation

Usually the unit comes with one hard-disk drive installed in compartment HD 1, which is default-configured as a master. The jumper settings configuration of the installed hard-disk drives for the unit and compatible drives which can be used with this unit are listed in the table below. To install two hard disk drives in compartment HD 1 and HD 2, please take the following steps. (For removable model only)

The jumper settings of hard-disk drives for the system

| | Location | Jumper |
|-------|------------------|--------|
| IDE 1 | Compartment HD 1 | Master |
| IDE 2 | Compartment HD 2 | Master |

7.2.1 Built-in hard disk

1.



Unscrew all the **4** mounting screws on the mobile rack of the unit and detach it.

2.

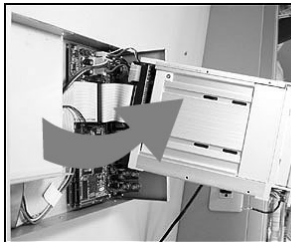

Carefully lift the mobile rack to a vertical position.

3.

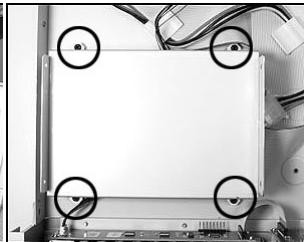

Unscrew the secured screws to detach the hard disk rack.

4.



Setting the jumper of your hard disk driver: The way to set the jumper of the drive varies between manufacturers; please refer to the instructions on the driver to set the jumpers in the **master** position.

5.



Place the hard disk in the rack.

6.

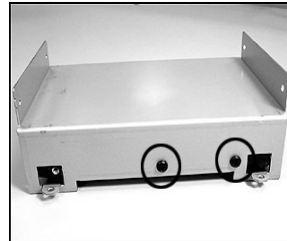

Secure the driver in the rack using **4** mounting screws in the side-mounting holes. Please don't tighten the screws too much, otherwise that may damage the driver.

7.

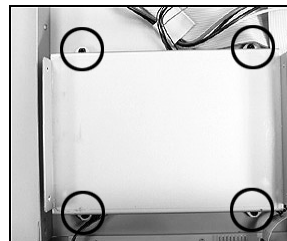

Screw the rack into the device, tightening in all the **4** screws.

8.

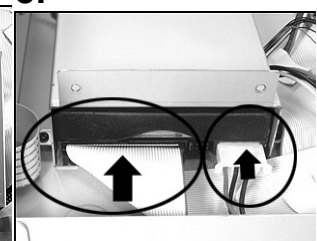

Attach the interface connector and the power connector to the drive. Please note the red lining of the IDE cable and the red wire of power cable must line up side by side.

9.

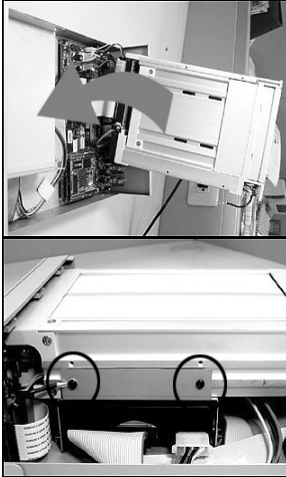

Place the mobile rack back onto the device and screw in all the **4** screws.

7.2.2 Mobile Rack (FOR REMOVABLE HDD MODEL)

1



Make sure that the key is unlocked.

2.



Pull the active handle outward to detach the carrier body from the mobile rack.

3.

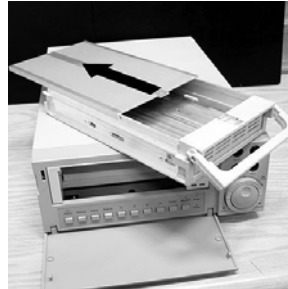

Slide the top cover backward and remove.

4.



Setting the jumper of your hard disk driver. The way to set the jumper of the drive varies between manufacturers; please refer to the instructions on the driver to set the jumpers in the master position.

5



Attach the interface connector and the power connector to the drive. Please note the red lining of the IDE cable and the red wire of power cable must line up side by side.

6

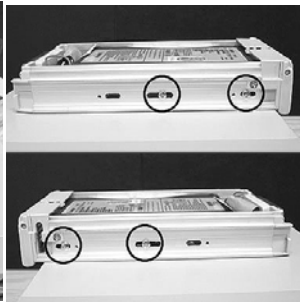

Place the HDD inside the mobile rack. Use four of the provided screws.

7

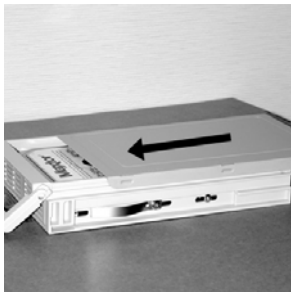

Place the top cover back on the carrier body by sliding it forward.

8



Slide the carrier body back in the mobile rack.

9



Push the carrier body further into the mobile rack until fully inserted.

11



Push the active-handle inward.

12

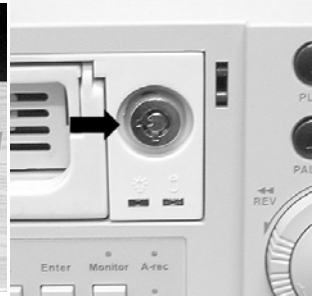

Lock the Key.

7.3 System Default

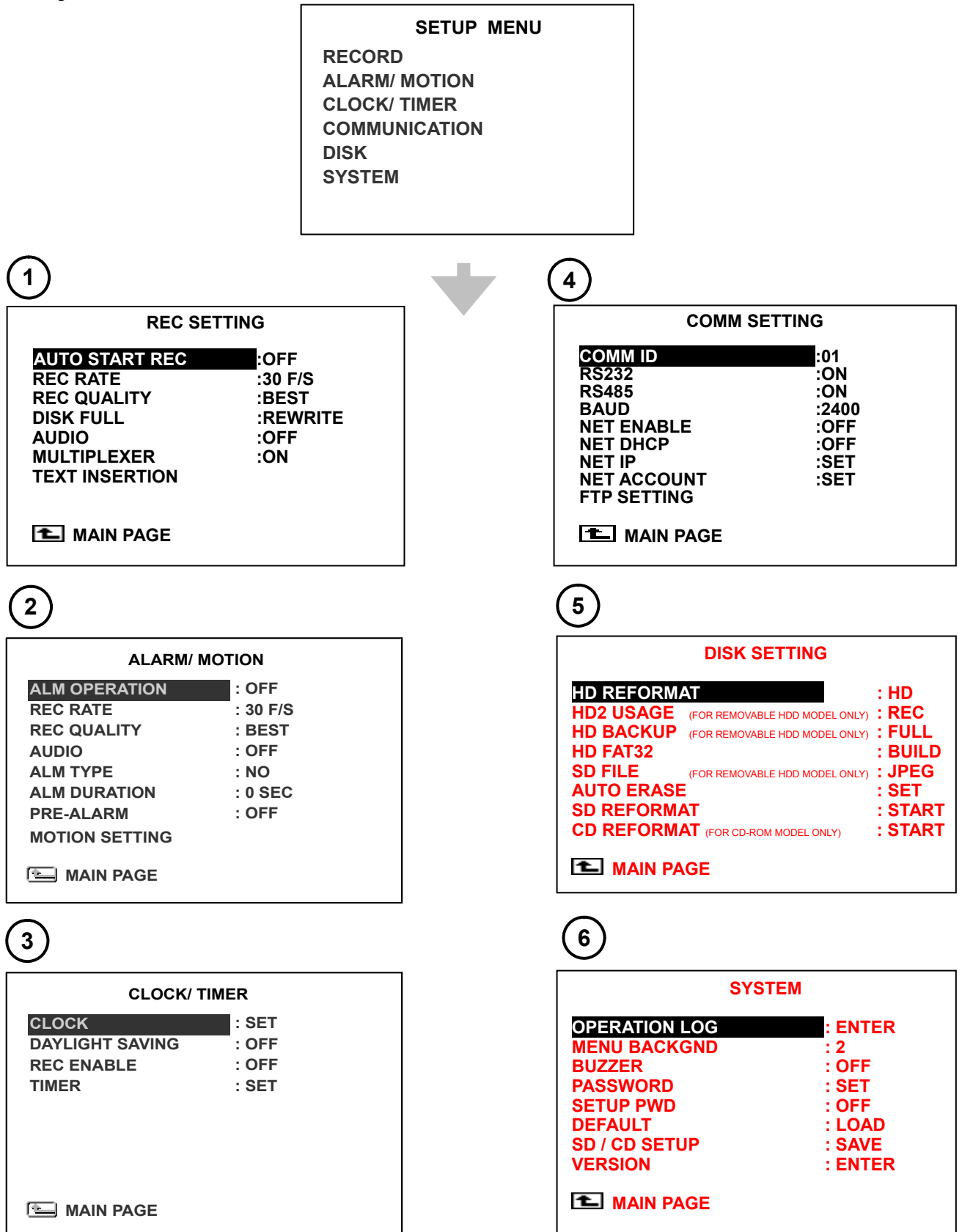

7.4 O.S.D Message

| No. | O.S.D Message | Meanings |
|-----|------------------------------|---|
| 1 | NO DISK | No hard-disk detected after power activated. |
| 2 | BATTERY LOW | Suggest change the battery and reset the system time. |
| 3 | LOADING | System Boot up. |
| 4 | VIDEO LOSS | Video loss. |
| 5 | VIDEO IN | Video input source. |
| 6 | KEY LOCKED | Key lock function is on. |
| 7 | KEY UNLOCKED | Key lock function is off. |
| 8 | n1 OF n2 ITEMS PROGRESS n3 % | BACKUP n1/n2 NOW. |
| 9 | BACKUP COMPLETE | Backup complete. |
| 10 | HD2 SPACE NOT ENOUGH | HD2 has not enough space for backup. |
| 11 | NO ENTRY FOR BACKUP | No backup is possible. |
| 12 | BACKUP INCOMPLETE | Backup incomplete, since the user has pressed the STOP button to stop it. |
| 13 | NOT FOUND | The system cannot find a video in the Search function. |
| 14 | END | Playback of recorded video has reached the end point. |
| 15 | DISK FULL | Hard-disks are full; this happens only when the DISK FULL item in the setup menu is set to STOP. |
| 16 | EMPTY | The user presses the PLAY button or uses the SEARCH function, but no video can be played. |
| 17 | SET TO NTSC, PLS RESTART | System has to be set to NTSC, please reboot (PAL is similar). |
| 18 | SOFTWARE UPDATE | Software update. |
| 19 | PLEASE RESTART | The system should be rebooted after the software has been updated. |
| 20 | NO DISK | The user has pressed the Save key without putting in an SD card, or there is a disk error. |
| 21 | DATA NOT CONTINUOUS | The system finds data in installed HDs cannot be used contiguously. Suggest you remove HD2 from the system. |
| 22 | DISK ATTACHED | HD2 has been attached. |
| 23 | DISK REMOVED | HD2 has been removed. |
| 24 | FAN STOPPED | The chassis fan has stopped for over 30 seconds. |
| 25 | HDn ERROR AT xxxxx | There has been a hard-disk error during recording, where n is the hard-disk number and xxxxx is the hexadecimal location. |
| 26 | NOT PRESENT | When the user tries to clear a disk that was not attached in the setup menu. |
| 27 | SAVE TO DISK | Start saving to the JPEG file. |
| 28 | SAVE TO Fnnn. JPG | Saving to Fnnn. JPG (where nnn= 0..999) |
| 29 | SAVE OK | Save to the JPEG is ok. |
| 30 | SD CARD WRITE PROTECTION | An SD card is write-protected; or, there is an error. |

7.6 Specifications

| Model Number | MV-DR3000L | MV-DR3000CDL |
|---------------------------|---|--|
| Model | REMOVABLE HDD MODEL | CD-ROM MODEL |
| Image System | NTSC/PAL | |
| Resolution | NTSC: 720 x 240 pixels ; PAL: 720 x 288 pixels | |
| Video In | Composite Video In (BNC) x 1, Multiplexer Monitor In (BNC) x 1 | |
| Video Out | Composite Video Out (BNC) x 1, Multiplexer Monitor Out (BNC) x 1 | |
| Audio In/Out | Line In / Out (RCAx2), 16 bits, 11 KHz / 22KHz | |
| Storage Media | > 600 GB / 1 Fixed HDD, 1 Removable HDD | >300Gb / 1 Fixed HDD |
| Compression | MJPEG | |
| Memory Card | SD Card (JPEG / AVI) | |
| Archive | Hot Swappable Removable HD / SD Card | CD-RW / SD Card |
| Watermark | Digital Signature | |
| Recording Rate | NTSC: 60 ips (720x240); PAL:50 ips(720x288) | |
| Image Size | Best(48KB) / High(32KB) / Standard(21KB) / Basic(16KB) | |
| Recording Mode | Schedule / Manual / Alarm / Circular | |
| Alarm Recording | Event / Pre-Alarm / Post Alarm | |
| Pre-Alarm Recording | 100 pictures | |
| Playback Speeds | Frame Stepping, 1/16x,1/8x,1/4x,1/2x,1x,2x,4x,8x,16x,30x,100x | |
| Record Search | Alarm / Time / Event list / Filter(thumbnail) / SD card | Alarm / Time / Event list / Filter(thumbnail) / SD card / CD |
| OSD Language | English / Chinese(T) | |
| Set-up Menu | Multi-layer / Network setting | |
| Log list | 2000 records | |
| Alarm In/Out | 1 Alarm Input / 1 Alarm Output | |
| Built-in Buzzer | Yes | |
| Motion Detection | Yes | |
| Communication Port | RS-232, RS-485, and Ethernet Port | |
| Network Interface | Ethernet (RJ-45 10/100 base-Tx) x 1 | |
| Network Protocol | TCP/IP, DHCP, HTTP, UDP, FTP, PPP | |
| Software Upgrade | Upgrade via Memory Card(SD Card) | |
| Password Protection | Operation / Menu Setup / Remote Access | |
| Network Capabilities | Archives images as JPEG formats, Records multi-brand multiplexers, Remote-control live or recorded images | |
| Power Supply (AC adapter) | Input: 100V-240V, 50 Hz/60 Hz; Output: DC12V max 5A | |
| Dimensions | Half-size mountable 220 mm x 94 mm x 340 mm EIA 19" 2U | |
| Weight | About 3.9 kg | |
| Operation Temperature | 5°C ~ 40°C (41°F ~ 104°F) | |
| Regulation | FCC, CE | |
| Accessories Provided | AC Adapter x 1 | |
| | Instruction manual x 1 | |
| | Power cord x 1 | |
| | CD x 1 | |

*Design and specifications subject to change without notice

7.7 Compatible Multiplexer Devices

| Manufacturer | Model | N/P | Channel | COLORS | Work with DVR |
|--------------|----------------|------------|---------|------------|---------------|
| APPRO | MPX-9004, 9104 | NTSC / PAL | 4Ch | Color, B/W | ✓ |
| | MPX-9019, 9119 | NTSC / PAL | 9Ch | Color, B/W | ✓ |
| | MPX-9016, 9116 | NTSC / PAL | 16Ch | Color, B/W | ✓ |
| ATV | DPX9 | NTSC / PAL | 9 Ch | Color | ✓ |
| | DPX16 | NTSC / PAL | 16Ch | Color | ✓ |
| DM | SPC2/D/N/04M | NTSC / PAL | 4Ch | Color | ✓ |
| | SLDX16C | NTSC / PAL | 16Ch | Color | ✓ |
| WVC | MPX-C9D | PAL | 9Ch | Color | ✓ |
| | MPX-C16D | PAL | 16Ch | Color | ✓ |
| | TPX-C1600T | PAL | 16Ch | Color | ✓ |
| DYNACOLOR | D7291 | NTSC / PAL | 9Ch | Color | ✓ |
| | D7261 | NTSC / PAL | 16Ch | Color | ✓ |
| | D7260 | NTSC / PAL | 16Ch | Color | ✓ |
| Eneo | VBM-7001 | PAL | 4Ch | B/W | ✓ |
| | VCM-7001 | PAL | 4Ch | Color | ✓ |
| | VCMD-5016 | PAL | 16Ch | Color | ✓ |
| HISHARP | DX72 | NTSC / PAL | 16Ch | Color | ✓ |
| IBT | CX904 | NTSC / PAL | 4Ch | Color | ✓ |
| | CX916 | NTSC / PAL | 16Ch | Color | ✓ |
| KOBI | K-69C-4 | NTSC / PAL | 4Ch | Color | ✓ |
| | K-69C-9 | NTSC / PAL | 9Ch | Color | ✓ |
| | K-69C-16 | NTSC / PAL | 16Ch | Color | ✓ |
| MultiView | MV 14CD | NTSC / PAL | 4Ch | Color | ✓ |
| | MV 19CD | NTSC / PAL | 9Ch | Color | ✓ |
| | MV 116CD | NTSC / PAL | 16Ch | Color | ✓ |
| PELCO | Duplex 9CH | PAL | 9Ch | Color | ✓ |
| | Duplex 16CH | PAL | 16Ch | Color | ✓ |
| PROVIDEO | RMX-4CD | NTSC | 4Ch | Color | ✓ |
| | RMX-9CD | NTSC | 9Ch | Color | ✓ |
| | RMX-16CD | NTSC | 16Ch | Color | ✓ |
| ROBOT | MV16e | NTSC | 16Ch | B/W | ✓ |
| | MV96p | NTSC | 16Ch | Color | ✓ |
| | MV99p | PAL | 9Ch | Color | ✓ |
| Santec | 4channel | PAL | 4Ch | Color, B/W | ✓ |
| | 9channel | PAL | 9Ch | Color, B/W | ✓ |
| | 16channel | PAL | 16Ch | Color, B/W | ✓ |
| SANYO | MPX-CD163 | PAL | 16Ch | Color | ✓ |
| Sensormatic | RV2216 | NTSC | 16Ch | Color | ✓ |
| TOSHIBA | JK-MX16 | NTSC | 16Ch | Color | ✓ |
| Vantage | VDX04 | PAL | 4Ch | Color, B/W | ✓ |
| | VDX09 | PAL | 9Ch | Color, B/W | ✓ |
| | VDX16 | PAL | 16Ch | Color, B/W | ✓ |
| Videoline | S9104 | NTSC / PAL | 4Ch | Color | ✓ |
| | S9119 | NTSC / PAL | 9Ch | Color | ✓ |
| | S9116 | NTSC / PAL | 16Ch | COLOR | ✓ |

7.8 ScanIP

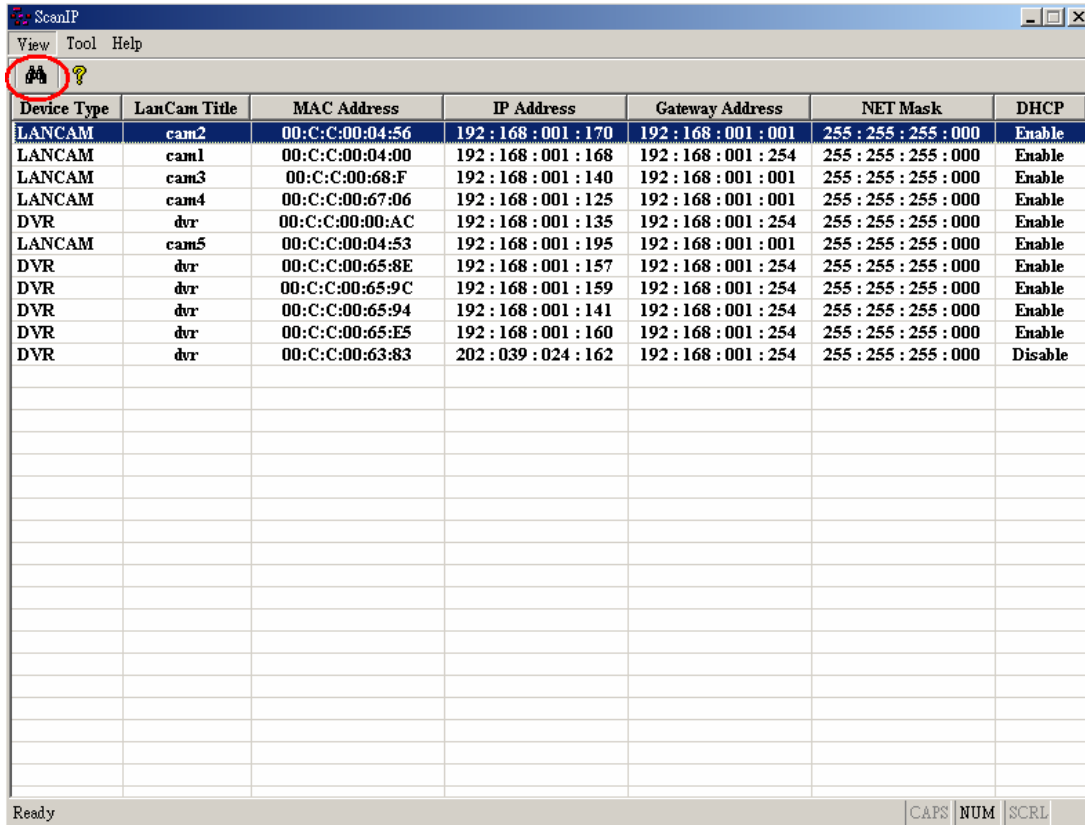

The screenshot shows the ScanIP application window with a menu bar (View, Tool, Help) and a toolbar containing a red circle around a network icon and a question mark. Below is a table listing discovered devices with their respective network configurations.

| Device Type | LanCam Title | MAC Address | IP Address | Gateway Address | NET Mask | DHCP |
|-------------|--------------|-----------------|-----------------|-----------------|-----------------|---------|
| LANCAM | cam2 | 00:C:C:00:04:56 | 192:168:001:170 | 192:168:001:001 | 255:255:255:000 | Enable |
| LANCAM | cam1 | 00:C:C:00:04:00 | 192:168:001:168 | 192:168:001:254 | 255:255:255:000 | Enable |
| LANCAM | cam3 | 00:C:C:00:68:F | 192:168:001:140 | 192:168:001:001 | 255:255:255:000 | Enable |
| LANCAM | cam4 | 00:C:C:00:67:06 | 192:168:001:125 | 192:168:001:001 | 255:255:255:000 | Enable |
| DVR | dvr | 00:C:C:00:00:AC | 192:168:001:135 | 192:168:001:254 | 255:255:255:000 | Enable |
| LANCAM | cam5 | 00:C:C:00:04:53 | 192:168:001:195 | 192:168:001:001 | 255:255:255:000 | Enable |
| DVR | dvr | 00:C:C:00:65:8E | 192:168:001:157 | 192:168:001:254 | 255:255:255:000 | Enable |
| DVR | dvr | 00:C:C:00:65:9C | 192:168:001:159 | 192:168:001:254 | 255:255:255:000 | Enable |
| DVR | dvr | 00:C:C:00:65:94 | 192:168:001:141 | 192:168:001:254 | 255:255:255:000 | Enable |
| DVR | dvr | 00:C:C:00:65:E5 | 192:168:001:160 | 192:168:001:254 | 255:255:255:000 | Enable |
| DVR | dvr | 00:C:C:00:63:83 | 202:039:024:162 | 192:168:001:254 | 255:255:255:000 | Disable |

Follow the instructions below to use the ScanIP software to search the DVR devices in a local network.

1. Click the  button to discover the connection of the all-type device in the LAN. The **Device List** will display the connection of the all-type device.
2. Select the desired device of the DVR from the **Device List**.
3. Click the desired device to show the window while the DVR information acts to display the desired changes instantly.
4. Do you want to execute an auto search for free IP?
If and when you want to auto search the free IP, select "Yes" or "No". If clicked "Yes" the software will provide the "Free IP Address" boxes on the right side of the window. If you click "No", these address boxes will not show.



5. Manual insertion of "Free IP Address".
If you have clicked "No", please manually type in insertions as required against the "Free IP Address", "Gateway Address", and "NET Mask". Follow each insertion you make by typing in the "Login Name" and "Password", and click "UPDATE" to send your alterations to the DVR.

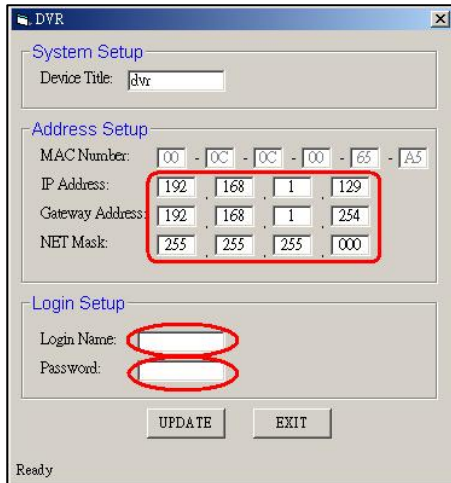

6. Auto search "Free IP Address".

If you clicked "Yes" the "Free IP Address" box will appear on the right.

2. To change any IP address, type in the new address in the "Free IP Address" box on the right as well as the device "Login Name" and "Password" in their respective blanks at bottom left, then click "UPDATE", and the new address will automatically be sent to the device.

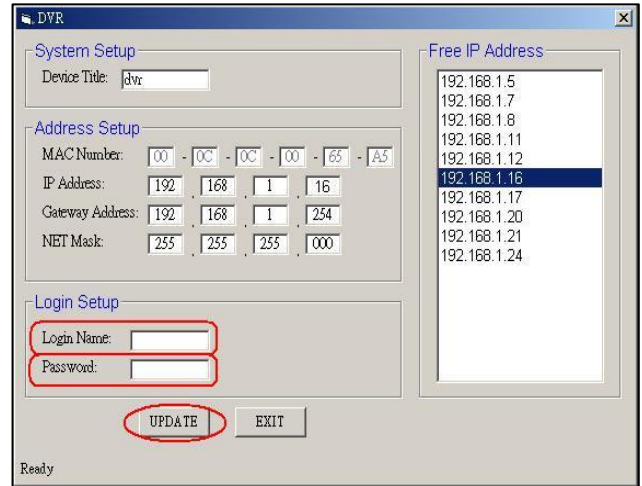

9. Click "Exit" at bottom right to shut the device.

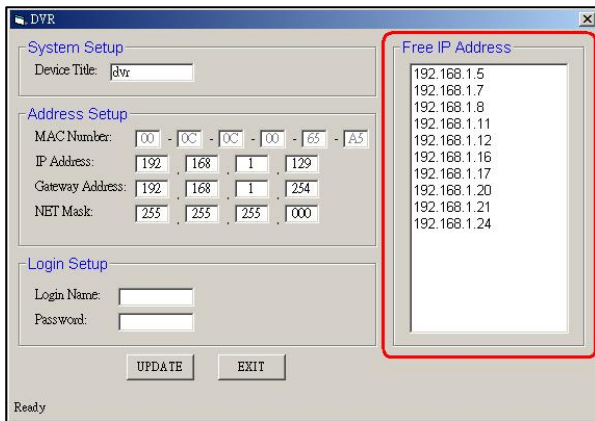

1. Select and double click any of the addresses in the "Free IP Address" box on the right to enter it into an IP Address on the left.

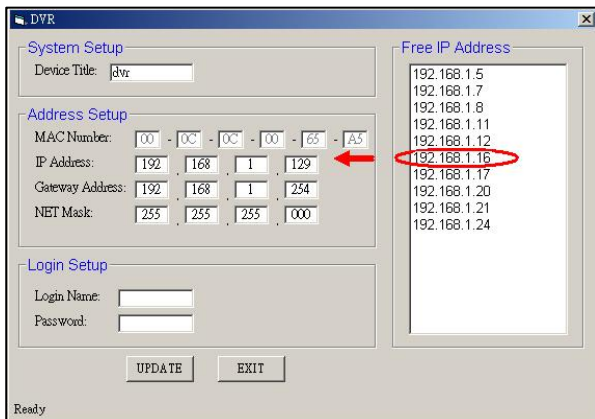

APPENDIX 1. – Using CD Discs (FOR CD-RW MODEL ONLY)

Please note that when using CD-ROM, CD-R and CD-RW discs, do not write or stick anything on the surface as this could cause an error in recording or the data on the disc may be damaged.

Inserting Disc

1. Please press the eject button.
2. Please place the disc in the tray.

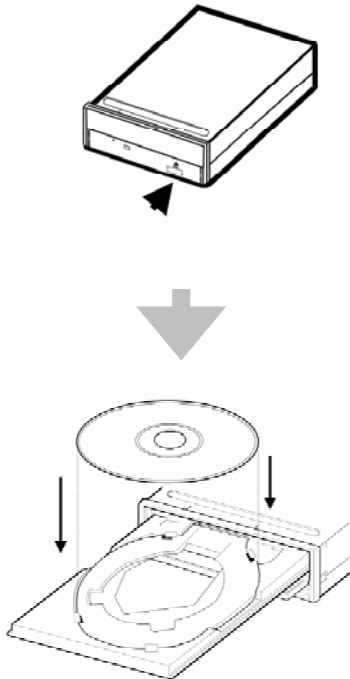

NOTE: When using a 12 cm disc please place it in the center of the caddy where you are able to see the larger position specifically for the 12 cm disc. When using an 8 cm disc please place it in the center of the caddy where you can see the position for the 8 cm disc. Please place the printed side up. Never place two discs in the caddy at the same time.

3. Please do not touch the surface of the disc where it has been recorded.
4. To insert the caddy please press the insert / eject button and hold the caddy lightly at the middle of its front and push gently to insert.

Ejecting The Disc

1. Press the eject button.
2. Carefully lift out the disc.
3. Press the eject button, or lightly touch the center of the tray and the tray will automatically reenter its position within the CD - RW recorder.

Caution: After the tray has been ejected and the disc has been retrieved from the caddy or put in the caddy, insert the tray in its original position to avoid the accumulation of dust or miscellaneous items inside the caddy, or else the pick up head may be affected when it needs to remain clean for effective reading of the data.

Emergency Eject Button

The device has an emergency eject button, which allows for manual retrieval of the disc in case the machine needs repair, or there is a cut in the power supply. In the above circumstances use the following method to eject the disc.

1. The power supply has been cut.
2. Press the emergency eject button with a needle (a paper clip, etc. can also be used) and the tray will immediately eject.

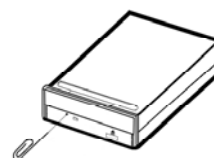

3. Press the front of the tray or lightly and gently pull the tray out with two fingers.

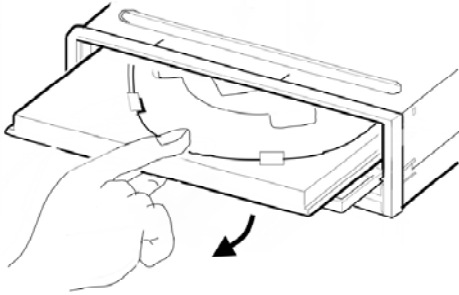

Caution

When you use either a CD-RW or a CD-ROM, please pay heed to the following.

1. At the time of installation: As suggested in your specifications, please do not install in an unstable position or in one that causes vibrations.
2. Do not install in high humidity, direct sunlight, or damp conditions.
3. Do not use near magnetic fields, or place near a television or a radio signal as the performance of the device may be affected.
4. Do not open to try to repair, as the laser may be harmful.

APPENDIX 2. –Default Text Insertion List

The following is a list of default phrases and exceptions. You can refer here to click and enter any item you need to check.

A. Default phrases.

| |
|------------------|
| ACCOUNT |
| ALCOHOL |
| ALE |
| AMERICAN EXPRESS |
| ATM |
| AX |
| BALANCE |
| BASS |
| BOURBON |
| BREAKFAST |
| BUDWEISER |
| BUD LITE |
| CASH |
| CHANGE |
| CHEW |
| CIGARS |
| COMBO |
| COORS |
| CORONA |
| CUSTOMER |
| DEBIT |
| DIESEL |
| DINERS |
| DINNER |
| DOUBLE |
| DRAFT |
| DISCOUNT |
| DISCOVER |
| EMPLOYEE |
| EXTRA |
| EXTRA LARGE |
| FISH |
| KEG |
| KIDS MEAL |
| GAS |
| GASOLINE |
| GIN |
| GUINNESS |
| HEINEKEN |

| |
|---------------|
| IMPORT |
| LAGER |
| LARGE |
| LONE STAR |
| LOTTERY |
| LUNCH |
| MALT |
| MASTER CHARGE |
| MEAL |
| MEAT |
| MEDIUM |
| MICHELOB |
| MILLER LITE |
| M/C |
| OIL |
| PERCENTAGE |
| PREMIUM |
| PONY KEG |
| RECEIVED |
| SALE |
| SCOTCH |
| SEAFOOD |
| SHOT |
| SMALL |
| SNUFF |
| SPECIAL |
| STOUT |
| SUB TOTAL |
| SYNTHETIC |
| TEQUILA |
| TOBACCO |
| TOP SHELF |
| VISA |
| VODKA |
| WHISKEY |
| X REPORT |
| Z REPORT |
| |
| |

B. Default exceptions

| | |
|-------------|---|
| BEER | * |
| CANCEL | * |
| CASH BACK | * |
| CASH OUT | * |
| CHARGE | * |
| CHECK | * |
| CIGARETTES | * |
| CIGS | * |
| COMP | * |
| CORRECTION | * |
| CREDIT | * |
| LIQUOR | * |
| MANAGER | * |
| MONEY ORDER | * |
| NO SALE | * |
| ON ACCOUNT | * |
| OVER RIDE | * |
| PAID OUT | * |
| PROMOTION | * |
| REFUND | * |
| RETURN | * |
| TOTAL | * |
| VOID | * |
| WINE | * |
| | |

(End)